

VSCode 的奇技淫巧

Yukai Huang

Study4TW .NET Conf 2019

[adult swim]



關於我

- Yukai
- HackMD 開發者 & 粉專小編
- VSCode Taiwan 粉專小編

信仰

- 我用 ~~neovim~~ VSCode 寫扣！
- 我用 空格 TAB 縮排！

VSCode 的奇技淫巧

奇_丷 技_扌 淫_氵 巧_丷
qí jì yín qiǎo



奇異而眩人耳目的技能或事物。《書經·泰誓下》：「郊社不修，宗廟不享，作奇技淫巧，以悅婦人。」《官場現形記·第四六回》：「臣是天朝的大臣，應該按照國家的制度辦事。什麼火車、輪船，走的雖快，總不外乎奇技淫巧。」也作「奇伎淫巧」。

奇 巧

炫人耳目的事物。《書經·泰誓》：「不享，作奇技淫巧，以悅。」《紅樓夢·第四六回》：「臣是天朝的大國，國家的制度辦事。什麼火車、輪船，走的雖快，總不外乎奇技淫巧。」也作「奇伎淫巧」。

總之就是炫炮

Outline

Outline

VSCode 簡介的部分

VSCode 獨步全球的部分

VSCode 奇技淫巧的部分

VSCode 簡介的部分

做個小調查

打開 VSCode 的官方網站...

Version 1.39 is now available! Read about the new features and fixes from September.

Code editing. Redefined.

Free. Built on open source. Runs everywhere.

Download for Mac
Stable Build

Other platforms and Insiders Edition

By using VS Code, you agree to its
license and privacy statement.

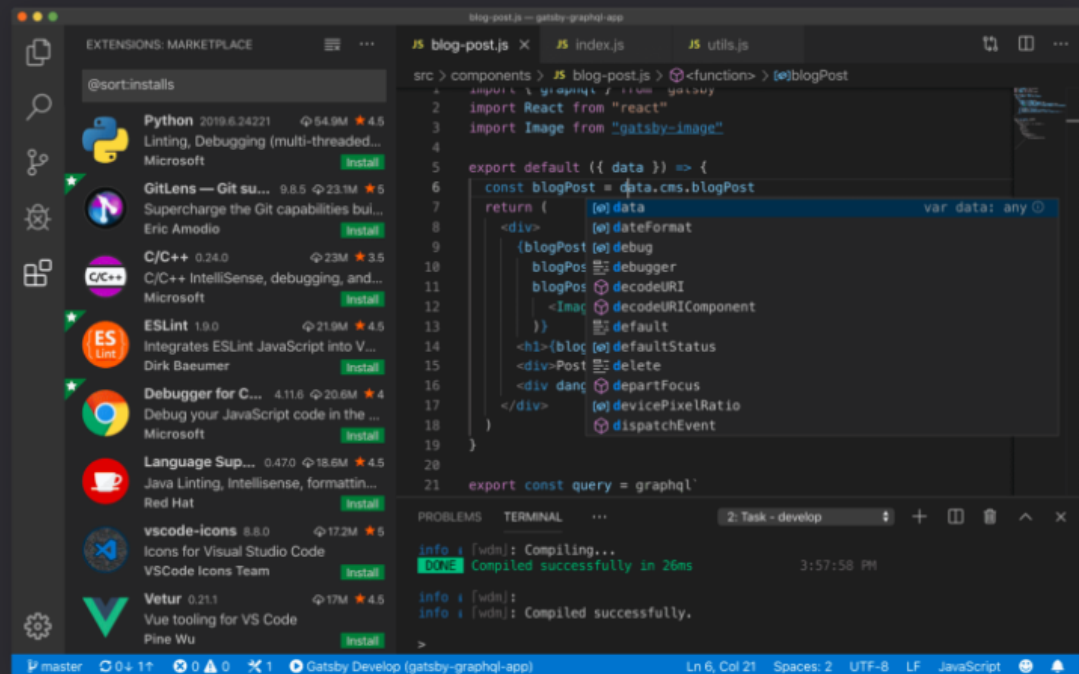

Code editing. Redefined.

Free. Built on open source. Runs everywhere.

程式碼編輯

程式碼編輯 重新定義



原來是重新定義的部分啊！

Editor

- 輕量
- 可以「支援」多種語言的語法上色
- 鍵盤為中心
- 自己的工作流自己弄
- vim, emacs, sublime, ...

IDE

- 專案系統
- 程式碼理解：跳轉定義、重構
- 內建除錯
- 介面設計
- Visual Studio, XCode, JetBrains 系列...
- ...

VSCode 呢？

從 Editor 往 IDE 靠近

- 維持編輯器的輕量高效
- 導入專案的概念
- 除錯器
- 語言支援(不只是程式碼上色)
- 任務管理
- ...

Technical Stack

Search or jump to...

Pull requests Issues Trending Explore

icrosoft / **vscode** x

Used by 448

Watch 2.8k

★ Unstar 85.9k

Fork 12.7k

code

Issues 3,753

Pull requests 128

Actions

Projects 2

Wiki

Security

Insights

Visual Studio Code code.visualstudio.com

itor

electron

visual-studio-code

typescript

microsoft

56,960 commits

343 branches

141 releases

1,016 contributors

MIT

TypeScript 93.3%

JavaScript 3.8%

CSS 1.8%

Inno Setup 0.7%

HTML 0.3%

Shell 0.1%

branch: master

1.40.0

Create new file

Upload files

Find file

Clone or download

jrieken Merge pull request #84331 from mjbvz/dont-drop-resolve-promise

Latest commit 81ab05a 2 hours ago

.github	Move new issue github link for questions to be a link to stack overflow	12 days ago
.vscode	update vs code default launch config	8 days ago
build	Merge branch 'master' into ben/test-custom-editor	17 hours ago
extensions	Improve scroll sync for nested markdown lists	14 hours ago
remote	chore: bump vscode-nsfw@1.2.8 (#84139)	2 days ago
resources	update to electron 6.0.x (#81644)	last month
scripts	Improve integration test output on Windows (#84239)	23 hours ago

Search or jump to...

Pull requests Issues Trending Explore

icrosoft / **vscode** x

Used by 448

Watch 2.8k

★ Unstar 85.9k

Fork 12.7k

code

Issues 3,753

Pull requests 128

Actions

Projects 2

Wiki

Security

Insights

Visual Studio Code code.visualstudio.com

itor

electron

visual-studio-code

typescript

microsoft

56,960 commits

343 branches

141 releases

1,016 contributors

MIT

93.3% TypeScript

TypeScript 93.3%

JavaScript 3.8%

CSS 8%

HTML 0.7%

Shell 0.1%

branch: master

1.40.0

Create new file

Upload files

Find file

Clone or download

jrieken Merge pull request #84331 from mjbvz/dont-drop-resolve-promise

Latest commit 81ab05a 2 hours ago

.github	Move new issue github link for questions to be a link to stack overflow	12 days ago
.vscode	update vs code default launch config	8 days ago
build	Merge branch 'master' into ben/test-custom-editor	17 hours ago
extensions	Improve scroll sync for nested markdown lists	14 hours ago
remote	chore: bump vscode-nsfw@1.2.8 (#84139)	2 days ago
resources	update to electron 6.0.x (#81644)	last month
scripts	Improve integration test output on Windows (#84239)	23 hours ago

TypeScript 不是拿來寫網頁的嗎？

EXPLORER

OPEN EDITORS

- provider.ts src
- extension.ts src
- package-lock.json

VSCODE-PTT

- vscode-ptt-open-article.gif
- media
- node_modules

src

- test
- extension.ts
- provider.ts
- pttDataProvider.ts
- store.ts

package-lock.json

package.json

README.md

tsconfig.json

tslint.json

vscode-ptt-0.0.1.vsix

OUTLINE

TODOS

```

"registry.npmjs.org/path-parse/-/path-parse-1.0.6.tgz",
"integrity":
"sha512-GSm0T2Eb
J8AENk3Qn70iKk4n
FYAu30te2
+JYNVvkpAEQm3/
TLNEJFD/
xZJjzyxg3KBW0zw=
=",
"dev": true
},
"performance-now":
{
"version":
"2.1.0",
"resolved":
"https://
registry.npmjs.
org/
performance-now/
-/
performance-now-
2.1.0.tgz",
"integrity":

```

Elements Console Sources

10 13

```

style="margin-left: 8px;">
...</div>
<div class="monaco-tl-
contents">
  <div class="monaco-
icon-label folder-icon
src-name-folder-icon
explorer-item" title="~/
Projects/vscode-
ptt/src" style="display:
flex;">...</div>
</div>
</div>
<div class="monaco-list-row"
role="treeitem" data-index=
"14" data-last-element="false"
aria-setsize="5" aria-
posinset="1" id="list_id_6_14"
aria-label="test" aria-level=
"2" draggable="true" style=
"top: 308px; height: 22px;
line-height: 22px;" aria-

```

body

Styles Event Listeners DOM Breakpoints Properties Accessibility

Filter :hov .cls +

```

element.style {
}
.mac, .windows, .linux {
  --monaco-monospace-font: "Sarasa Mono TC"
  !important;
}
.mac, .windows, .linux {
  font-family: "Sarasa UI TC" !important;
}
.mac {
  workbench.desktop.main.css:3
  --monaco-monospace-font: "SF
  Mono", Monaco, Menlo, Inconsolata, "Courier
  New", monospace;
}
.mac {
  workbench.desktop.main.css:3

```

margin -

border -

padding -

591 x 747

Filter Show all

- display block
- font-family "Saras...
- font-size 11px

A man in a dark suit, white shirt, and dark tie is shown from the chest up. He has a serious, thoughtful expression and is looking slightly to the left. The background is a blurred office setting with vertical blinds. The text '驚不驚喜？' and '意不意外？' is overlaid in white on the image.

驚不驚喜？
意不意外？

意不意外？

- **Built with Electron Framework**
- **Cross Platform
(Windows/macOS/Linux)**
- **Open source under MIT License**
 - VSCodeium

cross platform desktop apps with JavaScript, HTML, and

Electron Framework

Electron Framework

用網頁技術打造跨平臺的桌面應用程式

Electron Framework

用網頁技術打造跨平臺的桌面應用程式

HTML/CSS/JavaScript

- Slack
- Discord
- Microsoft Teams
- Figma
- GitKraken
- ...

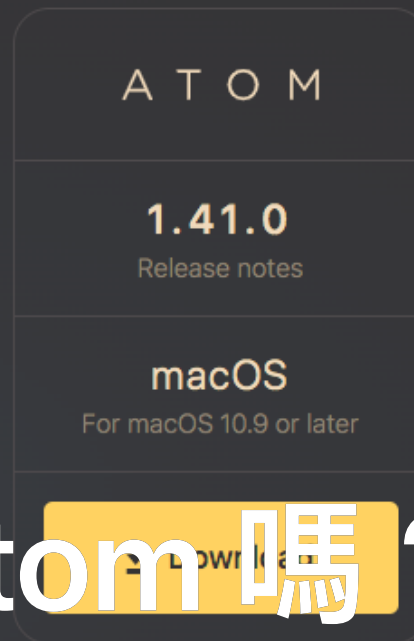

欸！那你有聽過 Atom 嗎？

By downloading, you agree to the Terms and Conditions.

[Other platforms](#)

[Try Atom Beta](#)

[Try Atom Nightly](#)

A hackable text editor for the 21st Century

Electron Framework

就是因此誕生

說回來 VSCode
對比 Atom 如何呢？

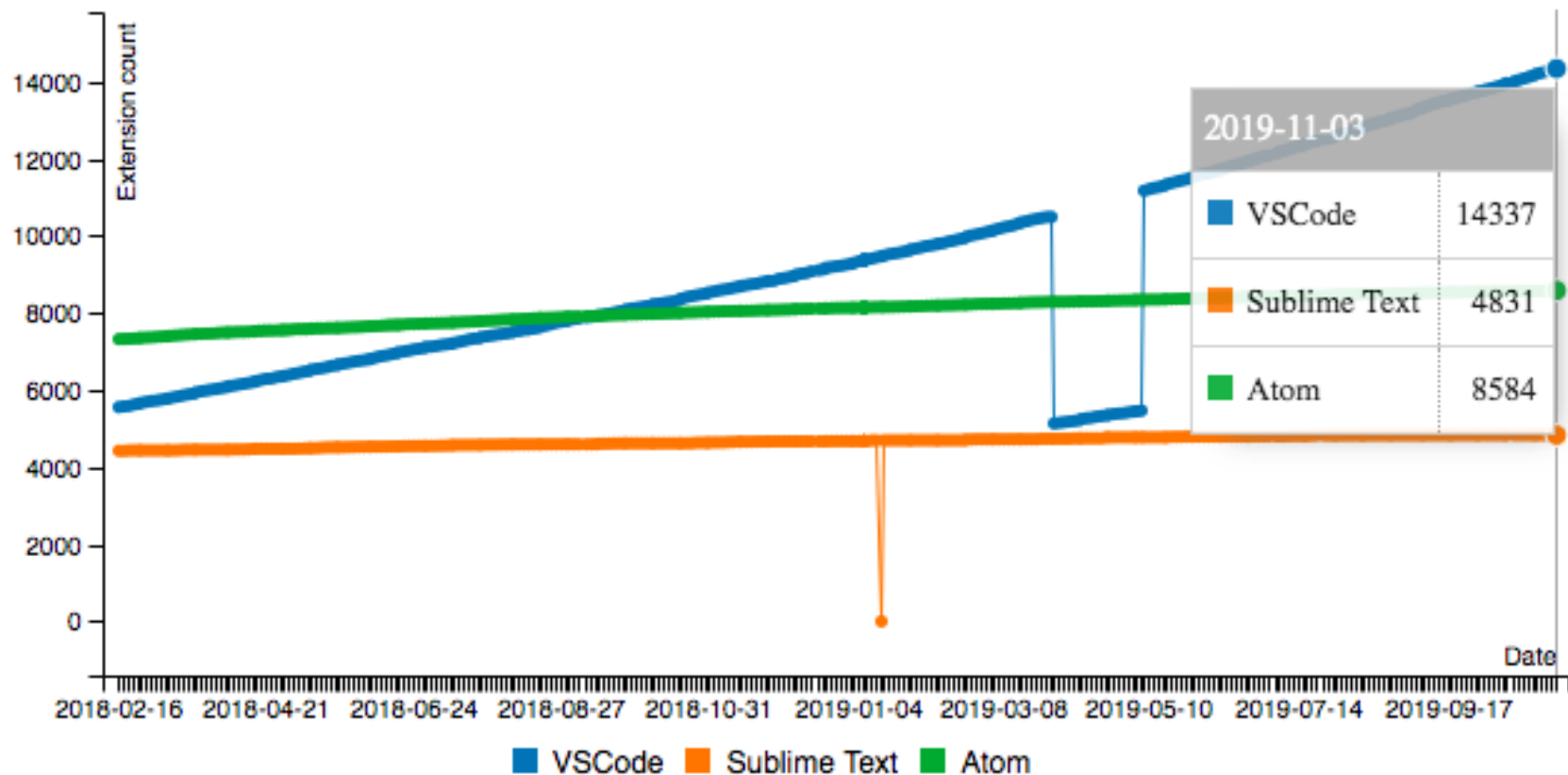

yukaii.tw/extension-stats



Development Environments and Tools

Most Popular Development Environments

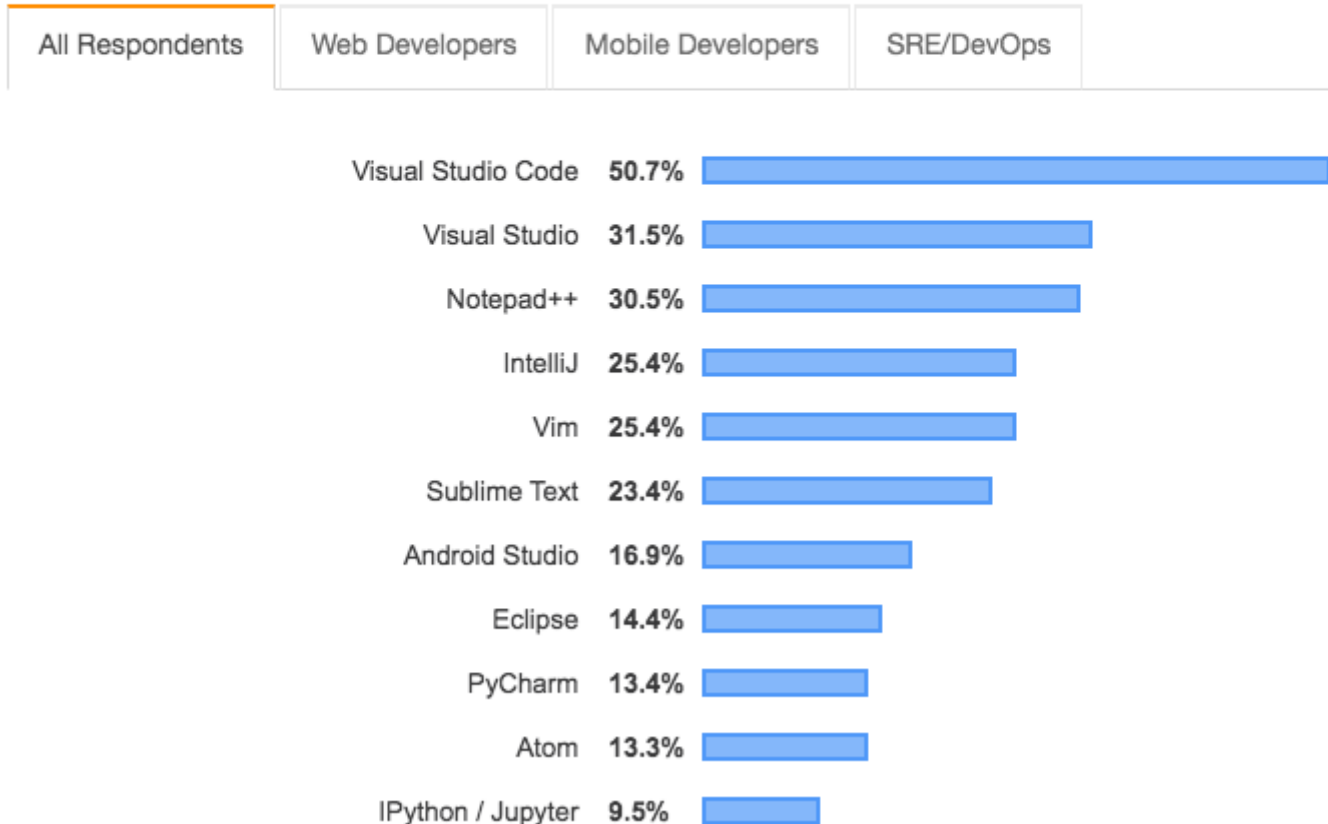

Stackoverflow survey 2019



Tim Pope

@tpope



when people ask me to recommend a text editor

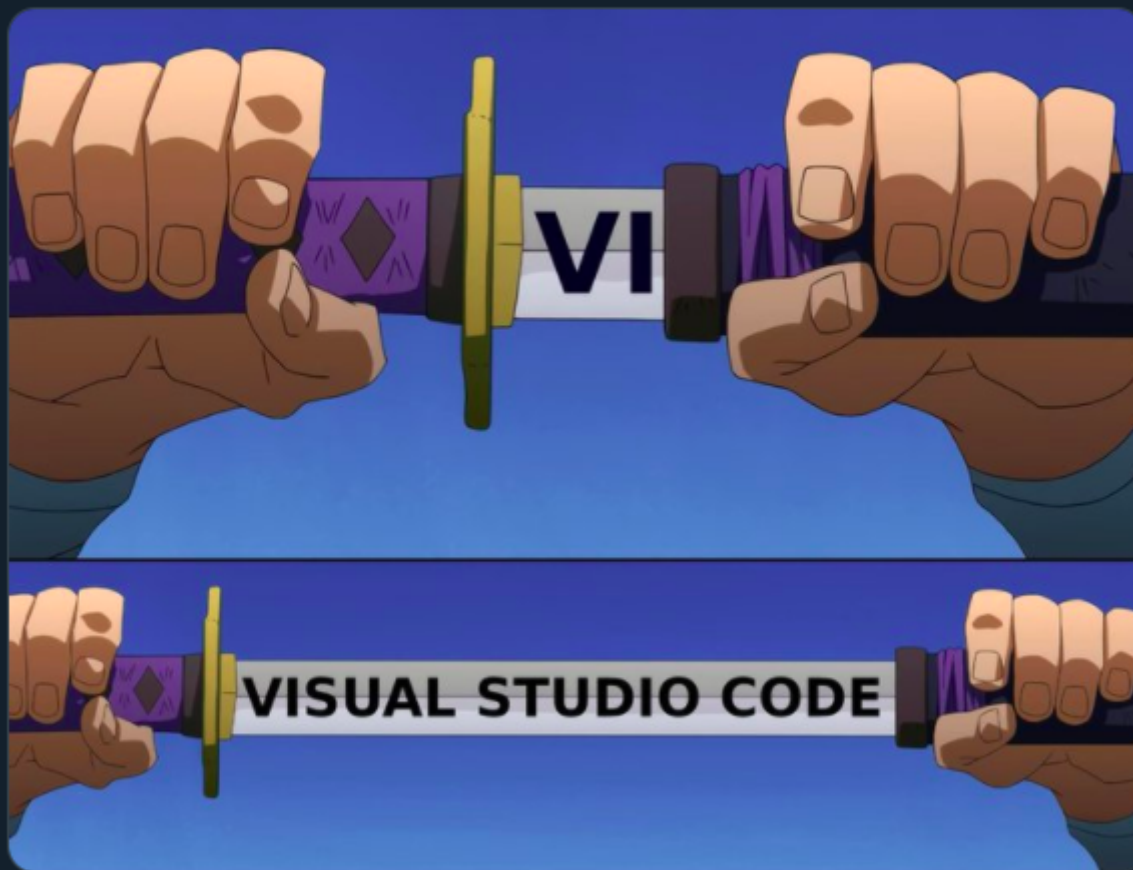

1:27 PM · Sep 14, 2019 · [Twitter Web App](#)

何德何能

VSCode 獨步全球的部分



VSCode 獨步全球的部分之一

Language Server Protocol

Language

Server

Protocol

語言伺服器通訊協定

編輯器或 IDE

編輯器或 IDE

與
語言
伺服器
Language Server

編輯器或 IDE

與
語言
伺服器

Language Server

溝通的協定

欸所以語言伺服器又是什麼？

Open Standard

實作 IDE 的各種功能

- Code completion
- Hover
- Jump to def
- Workspace symbols
- Find references
- Diagnostics
- ...

(langserver.org)

寫 1 套語言伺服器
支援 n 套編輯器/IDE

or...

寫 1 套編輯器/IDE
支援 n 種語言

A scene from the movie Toy Story featuring Woody and Buzz Lightyear. Woody is on the left, looking concerned with his hand on Buzz's shoulder. Buzz is on the right, wearing his iconic green and purple space suit and holding a green blaster. The background is a simple room with a blue wall and yellow stars.

LSP

LSP EVERYWHERE

目前支援幾種語言？

Implementations

Language Servers

If you are missing a server please create a pull request in GitHub against this markdown [document](#)

Language	Maintainer	Repository	Implementation Language
Ada/SPARK	AdaCore	ada_language_server	Ada
API Elements	Vincenzo Chianese(@XVincentX)	vscode-apielements	TypeScript
Apache Camel	Contributors	Apache Camel Language Server	Java
Apex	Salesforce	VS Code Apex extension	TypeScript
Ballerina	Ballerina.io	Ballerina Language Server	Java
Bash	Mads Hartmann	Bash Language Server	TypeScript
C#	OmniSharp	csharp-language-server-protocol	C#
C++	MS	VS Code C++ extension	C++

Implementations

Language Servers

If you are missing a server please create a pull request in GitHub against this markdown [document](#)

Language	Maintainer	Repository	Implementation Language
Ada/SPARK	AdaCore	ada_language_server	Ada
API Elements	Vincenzo Chiodi @VincenzoX	vs-code-api-elements	TypeScript
Apache Camel	Contributors	The Camel Language Server	Java
Apex	Salesforce	VS Code Apex extension	TypeScript
Ballerina	Ballerina.io	Ballerina Language Server	Java
Bash	Mads Hartmann	Bash Language Server	TypeScript
C#	OmniSharp	csharp-language-server-protocol	C#
C++	MS	VS Code C++ extension	C++

支援哪些 Editor/IDEs?

- Neovim: coc.nvim (neovim , 激推 !)
- Sublime: Sublime LSP
- Atom: Atom IDE
- ...

vimrc | p/j/index.js | p/c/index.css # webpack.common.js+ | JS p/j/l/e/index.js | p/j/l/e/statusbar.html <|

buff

```

> vendor/
> views/
.eslintrc.js
apple-touch-icon.png
codimd-icon-1024.png
default.md
favicon.png
screenshot.png
test/
utils/
babelrc
dockerignore
editorconfig
.gitignore
mailmap
sequelizerc
sequelizerc.example
.travis.yml
app.js
app.json
AUTHORS
config.json
config.json.example
CONTRIBUTING.md
ecosystem.config.js
LICENSE
package-lock.json
package.json
README.md
webpack.common.js
webpack.dev.js

```

```

11 const webpack = require('webpack')
10 const path = require('path')
9 const HtmlWebpackPlugin = require('html-webpack-plugin')
8 const CopyWebpackPlugin = require('copy-webpack-plugin')
7 const MiniCssExtractPlugin = require('mini-css-extract-plugin')
6
5 // Fix possible nofile-issues
4 const fs = require('fs')
3 const gracefulFs = require('graceful-fs')
2 gracefulFs.gracefulify(fs)
1
+ 12 fs.open|
+ 1 link~ f [TSC]
2 mo open~ f [TSC]
3 read~ f [TSC]
4 stat~ f [TSC]
5 chmod~ f [TSC]
6 chown~ f [TSC]
7 close~ f [TSC]
8 fstat~ f [TSC]
9 fsync~ f [TSC]
>> 10 lstat~ f [TSC]
>> 11 mkdir~ f [TSC]
12 rmdir~ f [TSC]
13 Stats C [TSC]
14 watch~ f [TSC]
15 write~ f [TSC]
16 access~ f [TSC]
17 Dirent C [TSC]
18 exists~ f [TSC]
19 fchmod~ f [TSC]
fchown~ f [TSC]

```

```

namespace open function open(path: PathLike, flags: string | number, mode:
string | number, callback: (err: NodeJS.ErrnoException, fd: number) => void):
void (+3 overloads)

```

Asynchronous open(2) - open and possibly create a file.

@param `path` - A path to a file. If a URL is provided, it must use the

```

jquery',
,
dlebars'
n({
views/includes/header.ejs',
index-styles', 'index'],
n(__dirname, 'public/views/build/index-header.ejs'),
lop webpack.common.js[+] javascript JS utf-8 2% 12/489 ln : 8 E:7(L

```

kai/Projects/HackMD/codimd

INSERT

webpack.common.js[+]

javascript JS

utf-8

2%

12/489 ln : 8

E:7(L

ning tags.

- vendor/
- views/
- eslinttrc.js
- apple-touch-icon.png
- codimd-icon-1024.png
- default.md
- favicon.png
- screenshot.png
- test/
- utils/
- .babelrc
- .dockerignore
- .editorconfig
- .gitignore
- .mailmap
- .sequelizerc
- .sequelizerc.example
- .travis.yml
- app.js
- app.json
- AUTHORS
- config.json
- config.json.example
- CONTRIBUTING.md
- ecosystem.config.js
- LICENSE
- package-lock.json
- package.json
- README.md
- webpack.common.js
- webpack.dev.js

```

11 const webpack = require('webpack')
10 const path = require('path')
9 const HtmlWebpackPlugin = require('html-webpack-plugin')
8 const CopyWebpackPlugin = require('copy-webpack-plugin')
7 const MiniCssExtractPlugin = require('mini-css-extract-plugin')
6
5 // Fix possible nofile-issues
4 const fs = require('fs')
3 const gracefulFs = require('graceful-fs')
2 gracefulFs.gracefulify(fs)
1
2 mo open~ f [TSC]
3 read~ f [TSC]
4 stat~ f [TSC]
5 chmod~ f [TSC]
6 chown~ f [TSC]
7 close~ f [TSC]
8 fstat~ f [TSC]
9 fsync~ f [TSC]
10 lstat~ f [TSC]
11 mkdir~ f [TSC]
12 rmdir~ f [TSC]
13 Stats C [TSC]
14 watch~ f [TSC]
15 write~ f [TSC]
16 access~ f [TSC]
17 Dirent C [TSC]
18 exists~ f [TSC]
19 fchmod~ f [TSC]
fchown~ f [TSC]

```

要把 VIM 改裝成真 IDE 就靠 LSP 啦！

歡迎大家跳槽 neovim

還有個東西叫 Debug Adapter Protocol

LSP 的 Debugger 版

LSP 的 Debugger 版

再等一等

VSCode 獨步全球的部分之二



SESSION DETAILS

Participants (3)

- Jon W Chu • Header.js:12
- Amanda Silver • GuestbookGrid.js:13
- PJ Meyer • GuestbookGrid.js:9

Shared Servers (2)

- localhost:3000
- REST API

Shared Terminals (2)

- bash (Read-only)
- bash (Read/write)

Audio Participants (3)

- Jon W Chu
- Amanda Silver
- PJ Meyer

```
1 import GridArrow from "../GridArrow";
2 import GridLegend from "../GridLegend";
3 import GuestbookGridCell from "../GuestbookGridCell";
4
5 export default class GuestbookGrid extends Component {
6   constructor(props) {
7     super(props)
8     this.state = PJ Meyer
9     signatures: signatures
10  }
11 }
12 Amanda Silver
13 render() {
14   const cells = this.state.signatures.map((signature, index) => (
15     <GuestbookGridCell key={index} {...signature} />
16   ));
17 }
18 }
```

Visual Studio Live Share

```
37
38 * @param {Array} activeSignatures - An array of active signatures
39 */
40 updateActiveSignature(activeSignatures) {
41   activeSignatures.forEach(signature => delete signature.isActive);
42
43   const activeSignature = Math.floor(Math.random() * activeSignatures.length);
44   activeSignatures[activeSignature].i
45
46   this.setState({ signatures: this.state.signatures });
47 }
48
49
50
51
52
53
54
55
56
57
58 * @param {Array} activeSignatures - An array of active signatures
59 */
60 updateActiveSignature(activeSignatures) {
61   activeSignatures.forEach(signature => delete signature.isActive);
62
63   const activeSignature = Math.floor(Math.random() * activeSignatures.length)
64   activeSignatures[activeSignature].i
65
66   this.setState({ signatures: this.state.signatures });
67 }
```

No-hassle sharing for any language, any app

It doesn't matter what type of app you're building, what language you're programming in, or what OS you're on: when you need to collaborate, Live Share will instantly share your project with a teammate. Edit and debug together in real time without teammates needing to clone a repo or set up their environment.

[Start collaborating >](#)

- Code
- Terminal
- Server
- Audio
- Chat
- ...

VS Live Share Extension API

Enables other VS Code extensions to access Live Share capabilities.

API Overview

Loading the Live Share API

Import the `vsls` module and call the `getApi()` function first to get the main API.

```
import * as vsls from 'vsls';

const liveshare = await vsls.getApi();
```

This function tries to get a version of the API that is compatible with the version of the referenced npm package. It returns `null` if the Live Share extension or requested API version is not available. Otherwise the returned object provides all the following APIs:

Session control

- `share()` - Starts a new session, sharing the currently opened workspace.
- `join()` - Joins a shared session using a link acquired from the host.
- `end()` - Ends or disconnects from the current sharing session.

Session state

- `session` property - Gets the current session ID, role (Host, Guest, or None), access level (Owner, ReadWrite, ReadOnly), and peer (unique among session participants), and Live Share user profile information.
- `onDidChangeSession` event - Notifies when the session state changes.

Peers

- `peers` property - Lists other participants in the session, including their role, access level, peer number, and user profile information.

install

```
> npm i vsls
```

± weekly downloads

6,238



version

0.3.1291

license

SEE LICENSE IN L...

open issues

445

pull requests

2

homepage

aka.ms

repository

 github

last publish

8 months ago

collaborators



 Test with RunKit

Report a vulnerability



Live Share Chat x

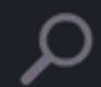

Friday, December 21

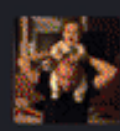

Jonathan Carter 4:34 AM
has started the Live Share session

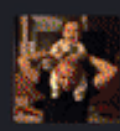

Jonathan Carter 4:35 AM
has joined the Live Share session

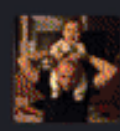

Jonathan Carter 4:39 AM
Let me show you how Redux works (well...kind of)

Message Live Share Chat



Live Share Chat x

Live Share Whiteboard

Friday, December 21

Jonathan Carter 4:34 AM
has started the Live Share session

Jonathan Carter 4:35 AM
has joined the Live Share session

Jonathan Carter 4:39 AM
Let me show you how Redux works (well...kind of)

Message Live Share Chat



master*



Jonathan



1



lostintan

打造 Live Share 大平台！



Bonus: 解包 VSLS

`~/ .vscode/extensions`

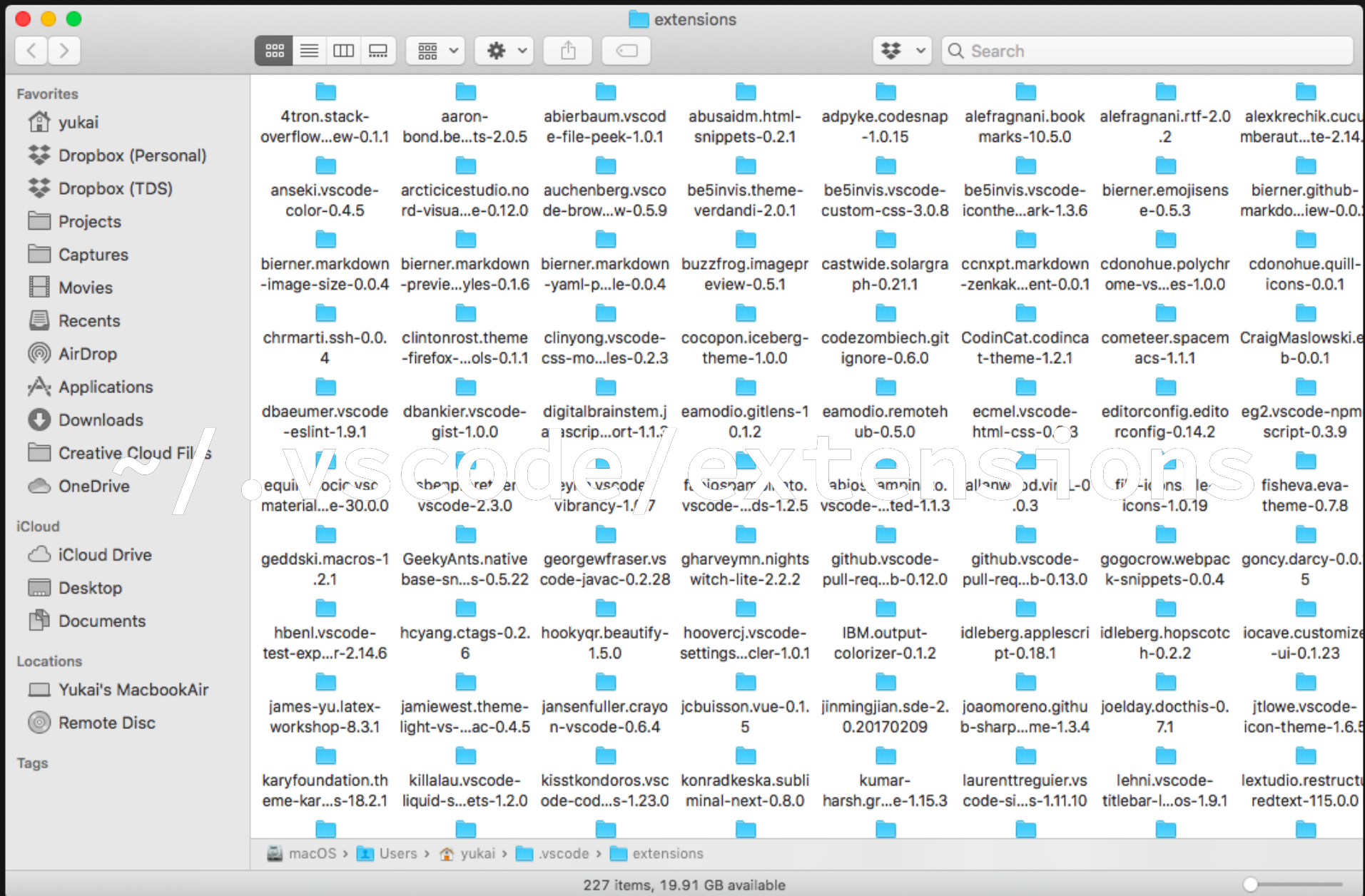

```
~ cd ~/.vscode/extensions/ms-vsiveshare.vsliveshare-1.0.1123/out/prod/
```

```
~/.v/e/m/o/prod ls
```

```
Mon Nov 4 22:46:38 2019
```

```
electronSignIn          nls.bundle.it.json      nls.bundle.zh-cn.json  
extension-prod.js       nls.bundle.ja.json      nls.bundle.zh-tw.json  
extension-prod.js.map   nls.bundle.json         nls.metadata.header.json  
nls.bundle.de.json     nls.bundle.ko.json      nls.metadata.json  
nls.bundle.es.json     nls.bundle.pt-br.json   uninstall.js  
nls.bundle.fr.json     nls.bundle.ru.json      welcomePage  
nls.bundle.hu.json     nls.bundle.tr.json
```

```
~ cd ~/.vscode/extensions/ms-vsiveshare.vsliveshare-1.0.1123/out/prod/
~/.v/e/m/o/prod ls Mon Nov 4 22:46:38 2019
electronSignIn      nls.bundle.it.json  nls.bundle.zh-cn.json
extension-prod.js   nls.bundle.ja.json  nls.bundle.zh-tw.json
extension-prod.js.map nls.bundle.json     nls.metadata.header.json
nls.bundle.de.json nls.bundle.ko.json  nls.metadata.json
nls.bundle.es.json nls.bundle.pt-br.json  uninstall.js
nls.bundle.fr.json nls.bundle.ru.json   welcomePage
nls.bundle.hu.json nls.bundle.tr.json
```

Sourcemapper

Sourcemapper is a bit of go lang to parse a sourcemap, as generated by webpack or similar, and spit out the original JavaScript files, recreating the source tree based on the file paths in the sourcemap.

An article explaining its purpose is available here: pulsesecurity.co.nz/articles/javascript-from-sourcemaps

Usage

```
:~$ ./sourcemapper
Usage of ./sourcemapper:
  -help
      Show help
  -output string
      Source file output directory
  -url string
      URL to the Sourcemap file
```

Sourcemapper will download the map file at `url`, and then spit the sources out into the directory defined by `output`

```
doi@asov:~$ ./sourcemapper -o dhubsrc -u https://hub.docker.com/public/js/client.356c14916fb23f85707f.js.map
[+] Retriving Sourcemap from https://hub.docker.com/public/js/client.356c14916fb23f85707f.js.map
[+] Read 23045027 bytes, parsing JSON
[+] Retrieved Sourcemap with version 3, containing 1828 entries
[+] Writing 9076765 bytes to dhubsrc/webpack:/js/client.356c14916fb23f85707f.js
```

denandz/sourcemapper

```
go get -u -v github.com/denandz/sourcemappper  
  
ruby -run -e httpd -- . -p 8000  
  
sourcemappper \  
  -url http://localhost:8000/extension-prod.js.map \  
  -output src
```

	Initial commit for 1.0.1123	Latest commit 3180557 5 days ago
new	Initial commit for 1.0.1123	5 days ago
abTests	Initial commit for 1.0.1123	5 days ago
abstractions/node	Initial commit for 1.0.1123	5 days ago
accessControl	Initial commit for 1.0.1123	5 days ago
api	Initial commit for 1.0.1123	5 days ago
auth	Initial commit for 1.0.1123	5 days ago
coediting	Initial commit for 1.0.1123	5 days ago
comments	Initial commit for 1.0.1123	5 days ago
contactService	Initial commit for 1.0.1123	5 days ago
contracts	Initial commit for 1.0.1123	5 days ago
debugger	Initial commit for 1.0.1123	5 days ago
electronSignIn	Initial commit for 1.0.1123	5 days ago
languageService	Initial commit for 1.0.1123	5 days ago
opportunisticLanguageService	Initial commit for 1.0.1123	5 days ago
servers	Initial commit for 1.0.1123	5 days ago
sourceControl	Initial commit for 1.0.1123	5 days ago
tasks	Initial commit for 1.0.1123	5 days ago
telemetry	Initial commit for 1.0.1123	5 days ago
terminals	Initial commit for 1.0.1123	5 days ago
treeViews	Initial commit for 1.0.1123	5 days ago

Bang!

▼  coediting

➤  client

▼  common

 OTAlgorithm.ts

 TransformManager.ts

 coauthoringService.ts

 coeditingUtils.ts

Algorithm
OT 演算法

Operational Transformation

- 即時協作演算法
- ex: Google Docs

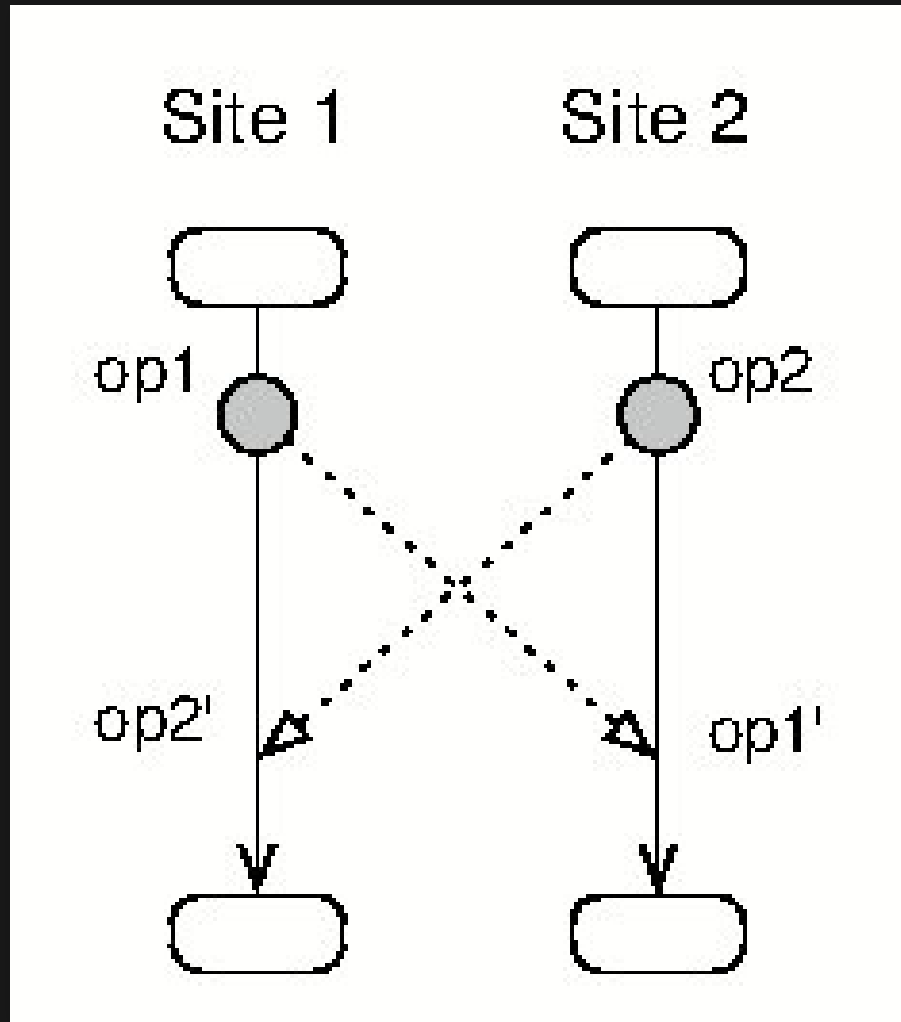

from wikipedia

說到 OT 就讓我想到...

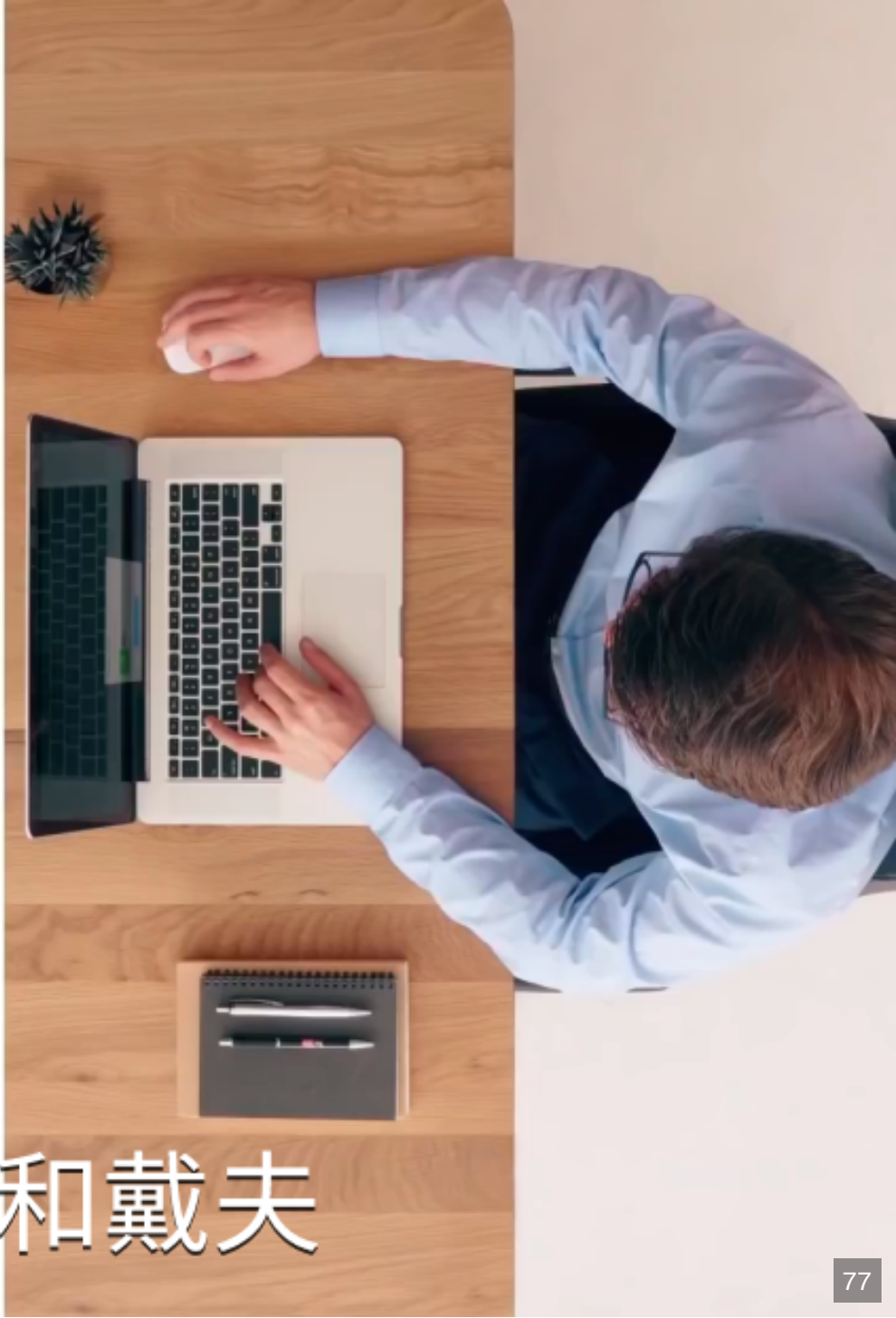

史蒂夫和戴夫



H**kMD

都使用 *ac*** 協作共筆

寫文件？

寫文件？

HackMD

大會共筆麻煩略過這一段謝謝



VSCode 獨步全球的部分之三



Remote Development

遠端開發

用本機的 VSCode 連線到遠端的機器做開發

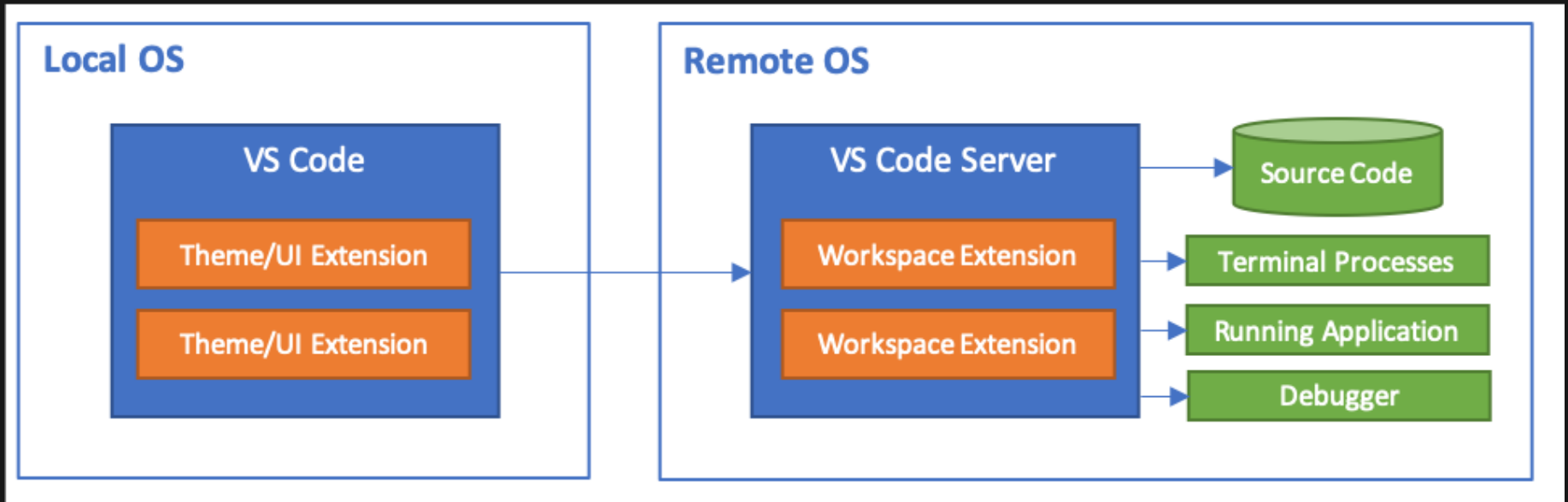

Microsoft Docs

**Language Server, Debugger,
Workspace Extension Process...**

放到 Remote 跑

**Language Server, Debugger,
Workspace Extension Process...**

放到 Remote 跑

介面那些還是放在本機

支援的 Remote 環境

- SSH
- Container
- WSL

Untitled-1 x

1

PROBLEMS OUTPUT DEBUG CONSOLE TERMINAL

1: htop, bash

CPU[|| 1.3%] Tasks: 42, 43 thr; 1 running
 Mem[||||||||| 236M/579M] Load average: 0.05 0.04 0.01
 Swp[0K/0K] Uptime: 00:10:21

PID	USER	PRI	NI	VIRT	RES	SHR	S	CPU%	MEM%	TIME+	Comm
1986	yukai	20	0	818M	54308	27988	S	0.7	9.2	0:01.24	/hom
2109	yukai	20	0	105M	3680	2668	S	0.7	0.6	0:00.02	sshd
2043	yukai	20	0	873M	66480	28704	R	0.0	11.2	0:01.31	/hom
2121	yukai	20	0	24220	4076	3216	S	0.0	0.7	0:00.23	htop
2138	yukai	20	0	24104	3768	3096	R	0.0	0.6	0:00.11	htop
1927	yukai	20	0	106M	3812	2332	S	0.0	0.6	0:00.11	sshd
1988	yukai	20	0	818M	54308	27988	S	0.0	9.2	0:00.05	/hom
1989	yukai	20	0	818M	54308	27988	S	0.0	9.2	0:00.06	/hom
1991	yukai	20	0	818M	54308	27988	S	0.0	9.2	0:00.04	/hom
2046	yukai	20	0	873M	66480	28704	S	0.0	11.2	0:00.03	/hom
1990	yukai	20	0	818M	54308	27988	S	0.0	9.2	0:00.06	/hom
1993	yukai	20	0	818M	54308	27988	S	0.0	9.2	0:00.01	/hom
1994	yukai	20	0	818M	54308	27988	S	0.0	9.2	0:00.01	/hom
1996	yukai	20	0	818M	54308	27988	S	0.0	9.2	0:00.01	/hom
1	root	20	0	220M	9064	6708	S	0.0	1.5	0:01.22	/sbi
203	root	19	-1	100M	8588	7864	S	0.0	1.4	0:00.18	/lib
209	root	20	0	97704	1832	1660	S	0.0	0.3	0:00.00	/sbi

F1 Help F2 Setup F3 Search F4 Filter F5 Tree F6 SortBy F7 Nice F8 Nice+ F9

SSH: dev 0 0 0 -- NORMAL -- Ln 1, Col 1 Spaces: 2 UTF-8 LF Markdown

```

yukai@dev:~$ cat /proc/cpuinfo
processor       : 0
vendor_id      : GenuineIntel
cpu family     : 6
model          : 79
model name     : Intel(R) Xeon(R) CPU @ 2.20GHz
stepping       : 0
microcode      : 0x1
cpu MHz        : 2200.000
cache size     : 56320 KB
physical id    : 0
siblings       : 1
core id        : 0
cpu cores      : 1
apicid         : 0
initial apicid : 0
fpu            : yes
fpu_exception : yes
cpuid level    : 13
wp             : yes
flags          : fpu vme de pse tsc msr pae mce cx8 apic sep mtrr
pge mca cmov pat pse36 clflush mmx fxsr sse sse2 ss ht syscall nx p
dpe1gb rdtscp lm constant_tsc rep_good nopl xtopology nonstop_tsc c
puid tsc_known_freq pni pclmulqdq ssse3 fma cx16 pcid sse4_1 sse4_2
  
```

Visual Studio Online

```
Visual Studio Online "Monaco" | monacotest
EXPLORE
  .settings
    user.json
  App_Code
  App_Data
  bin
  Content
  Contents
    _Blog.cshtml
    _Photos.cshtml
    _Twitter.cshtml
  images
  Layouts
  Scripts
  _AppStart.cshtml
  _PageStart.cshtml
  ContentPage.cshtml
  Default.cshtml
  favicon.ico
  hostingstart.html
  Web.config

_Blog.cshtml /Contents
1 @{
2     //Example: http://www.zdnet.com/blog/microsoft/rss
3     string blogUrl = "";
4 }
5
6 @if (String.IsNullOrEmpty(blogUrl)) {
7     <p>
8         Welcome to the RSS page! Please view the Contents/_Blog.cshtml page and provide
9         URL for the blog that you would like to display. Note that this page only supports
10        RSS 2.0 and Atom 1.0 feeds.
11    </p>
12 } else {
13     var feedItems = BlogHelper.GetFeedItems(blogUrl);
14     foreach (var item in feedItems) {
15         <article class="newsitem">
16             <div class="newsbody">
17                 <header>
18                     <h1>@item.Title</h1>
19                     <h2>@item.Author</h2>
20                 </header>
21                 <p class="pubdate">Published: <span>@item.PublishedDate.ToLocalTime().D
22                 <p>@Html.Raw(item.HtmlContent)</p>
23                 <a href="@item.WebUrl" target="_blank" data-role="button">Read more</a>
24             </div>
25         </article>
26     }
```

Visual Studio Online "Monaco" (2013)

Editor

Rich IntelliSense, Validation

TypeScript, JavaScript, CSS, LESS, SCSS, JSON, HTML

Basic Syntax Colorization

XML, PHP, C#, C++, Razor, Markdown, Diff, Java, VB, CoffeeScript, Handlebars, Batch, Pug, F#, Lua, Powershell, Python, Ruby, SASS, R, Objective-C

Colorizers are implemented using [Monarch](#).

Language Theme

```
1  /* Game of Life
2  * Implemented in TypeScript
3  * To learn more about TypeScript, please visit http://www.typescriptlang.org/
4  */
5
6  module Conway {
7
8      export class Cell {
9          public row: number;
10         public col: number;
11         public live: boolean;
12
13         constructor(row: number, col: number, live: boolean) {
14             this.row = row;
15             this.col = col;
16             this.live = live
17         }
18     }
19
20     export class GameOfLife {
21         private gridSize: number;
22         private canvasSize: number;
23         private lineColor: string;
```

Monaco Editor

再回到 VSCode

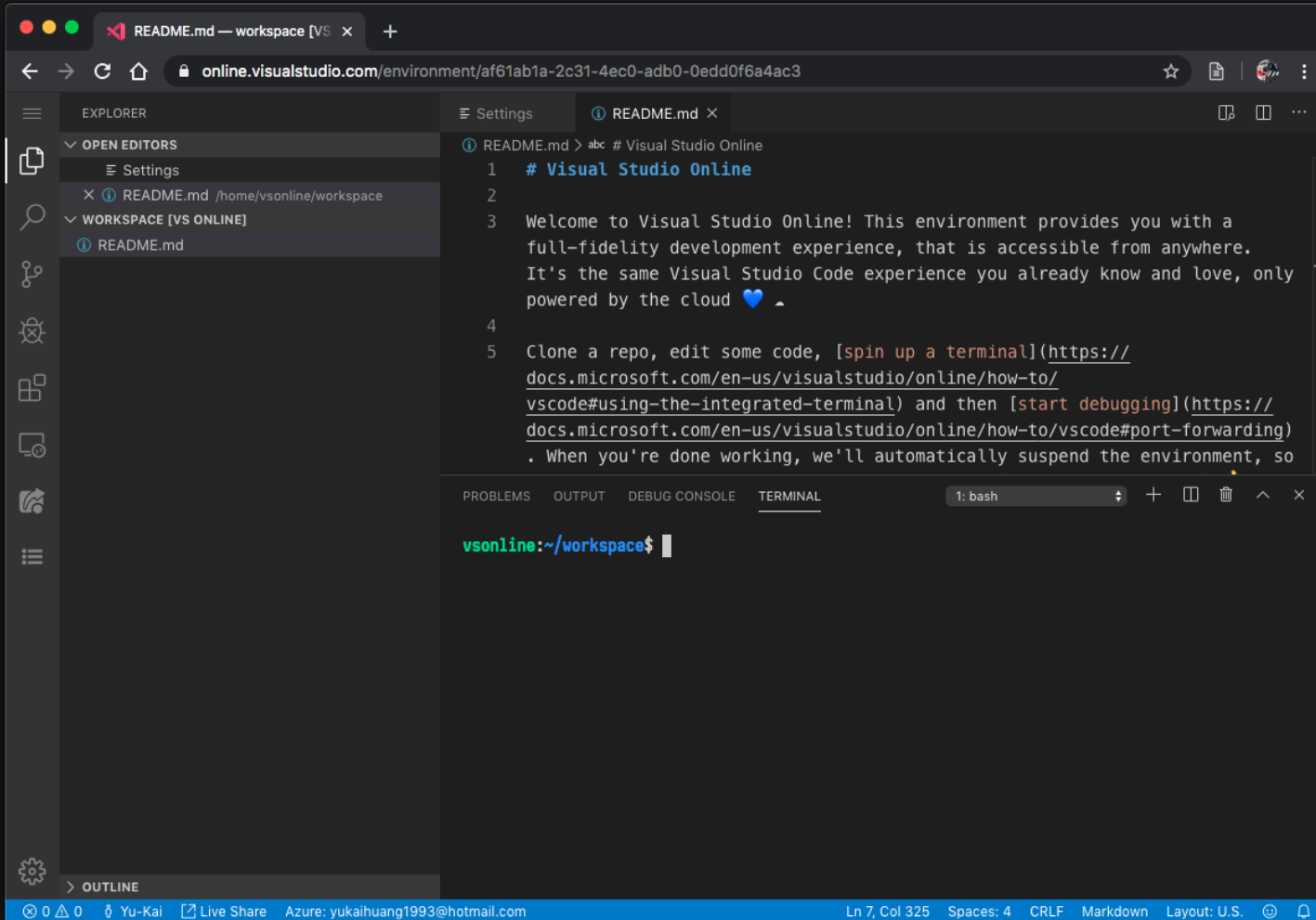

Visual Studio Online (2019)

“那真是太諷刺了，紹安，你離開你師傅繞了一大圈，最後到達的境界，竟然是你不想學... 還是要回到故鄉來的，這個四千里長江的盡頭上海，或許正是你的極限也說不定。”

~~欸不是啦！~~

集大成者

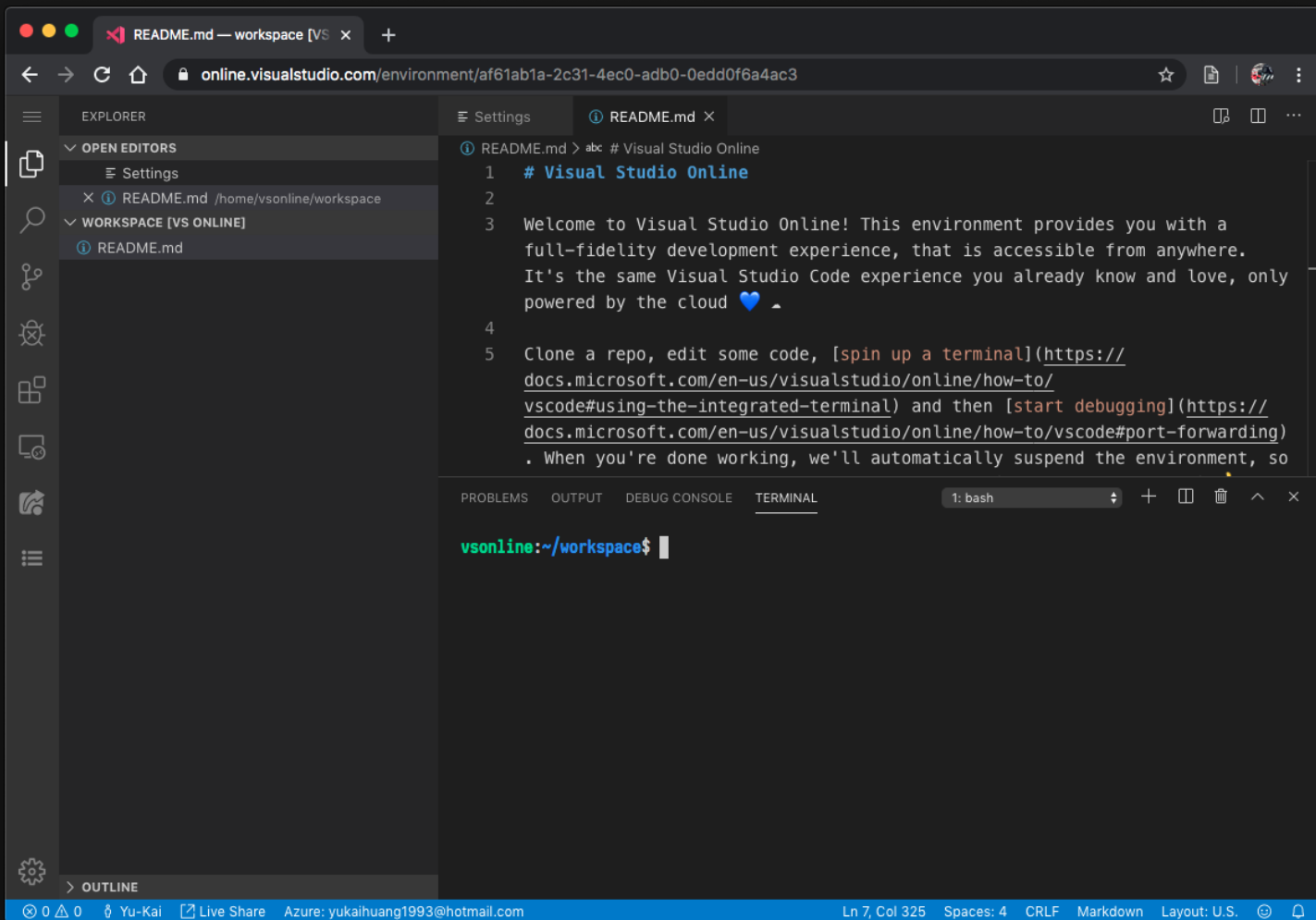

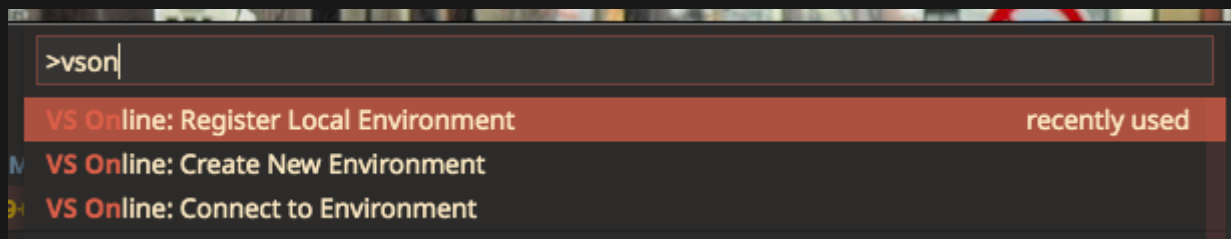

噢對了 Visual Studio Online 有自架版 (self-hosted)

Alternatives

- code server
- theia IDE (gitpod)
- CodeSandbox
- Eclipse Che
- Cloud9
- ...

VSCode 獨步全球的部分

- Visual Studio Live Share
- Remote Development
- Visual Studio Online



跳一下



VSCode 奇技淫巧的部分

Git/GitHub 擴充功能大補帖

- GitLens
- GitHub Pull Requests
- Git Graph

Git/GitHub 擴充功能大補帖

- → GitLens
- GitHub Pull Requests
- Git Graph



GitLens

Git supercharged

GitLens is an **open-source** extension for **Visual Studio Code**, created by **Eric Amodio**.

GitLens **supercharges** the Git capabilities built into Visual Studio Code. It helps you to **visualize code authorship** at a glance via Git blame annotations and code lens, **seamlessly navigate and explore** Git repositories, **gain valuable insights** via powerful comparison commands, and so much more.

GitLens simply helps you **better understand code**. Quickly glimpse into whom, why, and when a line or code block was changed. Jump back through history to **gain further insights** as to how and why the code evolved. Effortlessly explore the history and evolution of a codebase.

INSTALL GITLENS v10.1.1

or download from the **Visual Studio Marketplace**

SUPPORT GITLENS ❤️

While GitLens is generously offered to everyone free of charge, if you find it useful, please consider **supporting** it.

- **Git Blame**
- **File History**
- **Browse commit**
- **Link to GitHub**
- ...

三個我最常用的功能

- 檢視某個 commit 下的原始碼
- 檔案修改歷史
- 整個目錄比較

檢視某個 commit 下的原始碼

(Explore Repository from Revision)

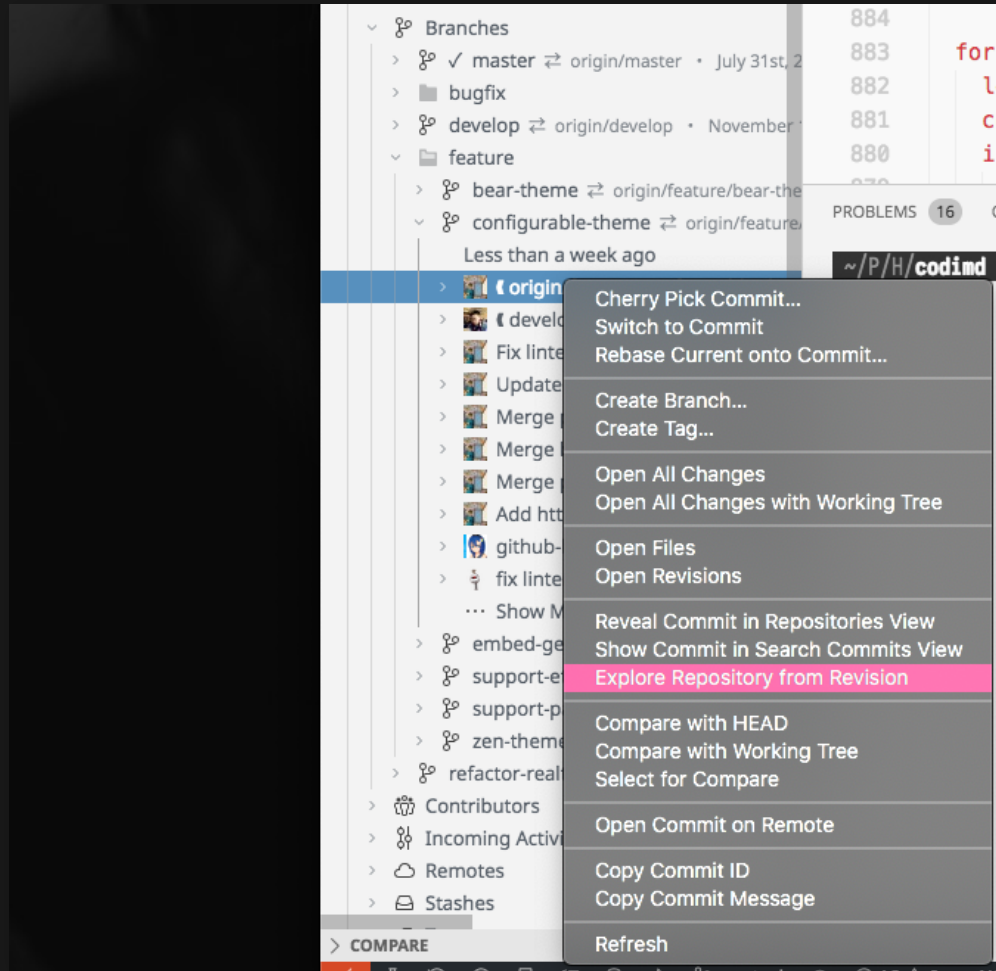

codimd

codimd @ 0471de5

bin

contribute

deployments

docs

lib

locales

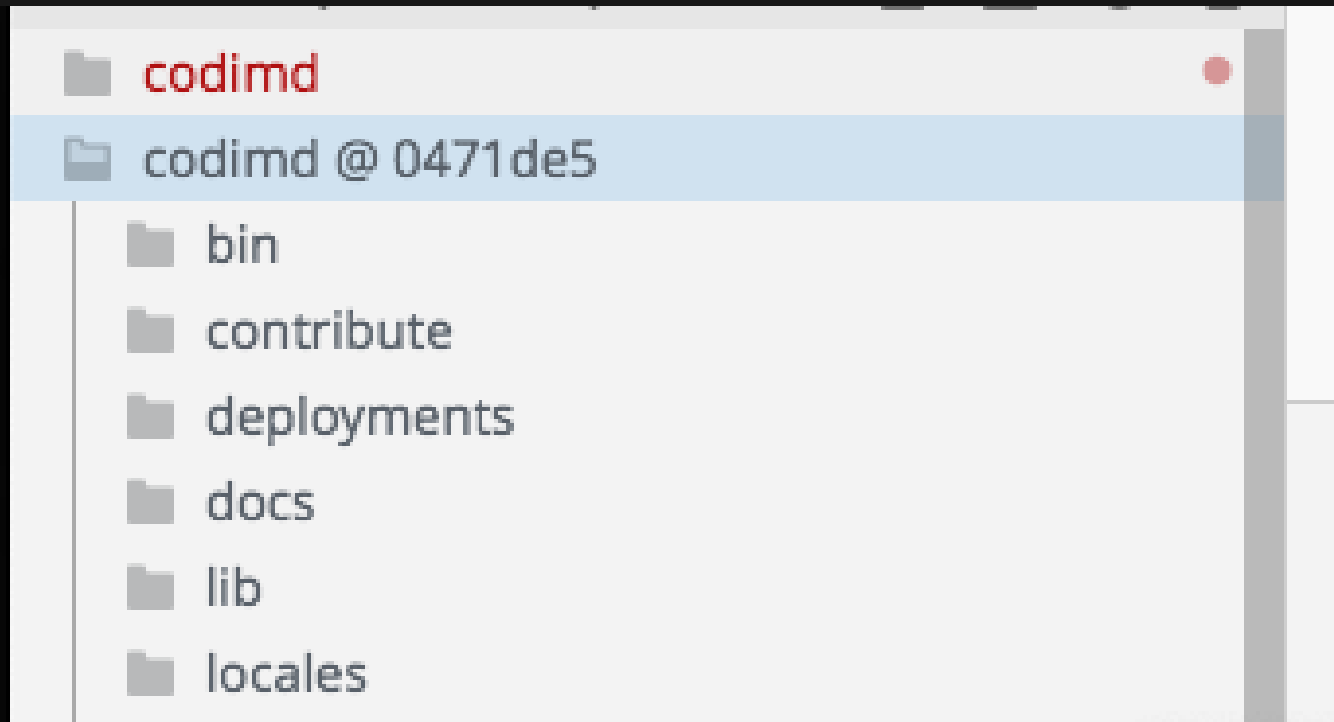

免 git subtree!

檔案修改歷史

SOURCE CONTROL: GIT

index.js

Message (⌘Enter to commit on 'master')

CHANGES 1

- ecosystem.config.js codimd U

GITLENS: FILE HISTORY

- index.js public/js
 - refactor: fix lint warning on public/js/index.js
 - fix: lint error ... +1 -1 · BoHong Li, April 12th, 2
 - refactor: replace js-url with wurl (original versi
 - refactor: replace Idle.js to @hackmd/idle-js ...
 - Fix CI errors for unused variables ... +2 -3 ·
 - Update from to-markdown to turndown ... +7
 - Fix wrong anchors ... +1 -0 · Sheogorath, Nov
 - switching to eslint for code checking ... +3 -1
 - Add autocomplete for highlight.js languages i
 - Fix #986 : Visibility is now transmitted with git
 - Add possibility to choose between version v3
 - Fix linting and optimize some functions ... +2
 - Add a toolbar to Codemirror editor ... +9 -0 ·
 - Removing google drive integration ... +0 -104
 - Fix night mode button after restore ... +1 -0 ·

GITLENS: LINE HISTORY

GITLENS: SEARCH COMMITS

```
21
20
19
18
17
16
15
14
13
12
11
10
9
8
7
6
5
4
3
2
(editor.getValue(), slideOptions)
ui.area.markdown.html(slides)
window.RevealMarkdown.initialize()
// prevent XSS
ui.area.markdown.html(preventXSS
(ui.area.markdown.html()))
ui.area.markdown.addClass('slides')
appState.syncscroll = false
checkSyncToggle()
} else {
  if (lastMeta.type && lastMeta.type === 'slide') {
    refreshView()
    ui.area.markdown.removeClass('slides')
    appState.syncscroll = true
    checkSyncToggle()
  }
  // only render again when meta changed
  if (JSON.stringify(md.meta) !== JSON.stringify
(lastMeta)) {
    parseMeta(md, ui.area.codemirror, ui.area.markdown,
$('#ui-toc'), $('#ui-toc-affix'))
    rendered = md.render(value)
  }
  // prevent XSS
  rendered = preventXSS(rendered)
  var result = postProcess(rendered).children().toArray
```

Spaces: 2 UTF-8 LF Babel JavaScript 1.5 hrs | 37 min

SOURCE CONTROL: GIT

Message (⌘Enter to commit on 'master')

CHANGES 1

- ecosystem.config.js codimd U

GITLENS: FILE HISTORY

- index.js public/js
 - refactor: fix lint warning on public/js/index.js
 - fix: lint error ... +1 -1 · BoHong Li, April 12th, 2
 - refactor: replace js-url with wurl (original vers
 - refactor: replace Idle.js to @hackmd/idle-js ...**
 - Fix CI errors for unused variables ... +2 -3 ·
 - Update from to-markdown to turndown ... +7
 - Fix wrong anchors ... +1 -0 · Sheogorath, Nov
 - switching to eslint for code checking ... +3 -1
 - Add autocomplete for highlight.js languages i
 - Fix #986 : Visibility is now transmitted with git
 - Add possibility to choose between version v3
 - Fix linting and optimize some functions ... +2
 - Add a toolbar to Codemirror editor ... +9 -0 ·
 - Removing google drive integration ... +0 -104
 - Fix night mode button after restore ... +1 -0

GITLENS: LINE HISTORY

GITLENS: SEARCH COMMITS

```
11 require('highlight.js/s
12
13 import TurndownService f
14
15 import { saveAs } from '
16 import randomColor from
17 import store from 'store
18 import hljs from 'highli
19
20 import _ from 'lodash'
21
22 import List from 'list.j
23
24 import {
25   checkLoginStateChang
26   setloginStateChangeE
27 } from './lib/common/log
28
29 import {
30   debug,
31   DROPBOX_APP_KEY,
32   noteid,
33   noteurl,
34   urlpath,
35   version
36 } from './lib/common/log
37
38 import { saveAs } from '
39 import randomColor from
40 import store from 'store
41 import hljs from 'highli
42
43 import _ from 'lodash'
44
45 import List from 'list.j
46
47 + import Idle from '@hackm
48
49 import {
50   checkLoginStateChang
51   setloginStateChangeE
52 } from './lib/common/log
53
54 import {
55   debug,
56   DROPBOX_APP_KEY,
57   noteid,
58   noteurl,
59   urlpath,
60   version
61 } from './lib/common/log
```

Spaces: 2 UTF-8 Babel JavaScript 1.5 hrs | 37 min

好！

整個目錄比較

Compare Ancestry with Working Tree

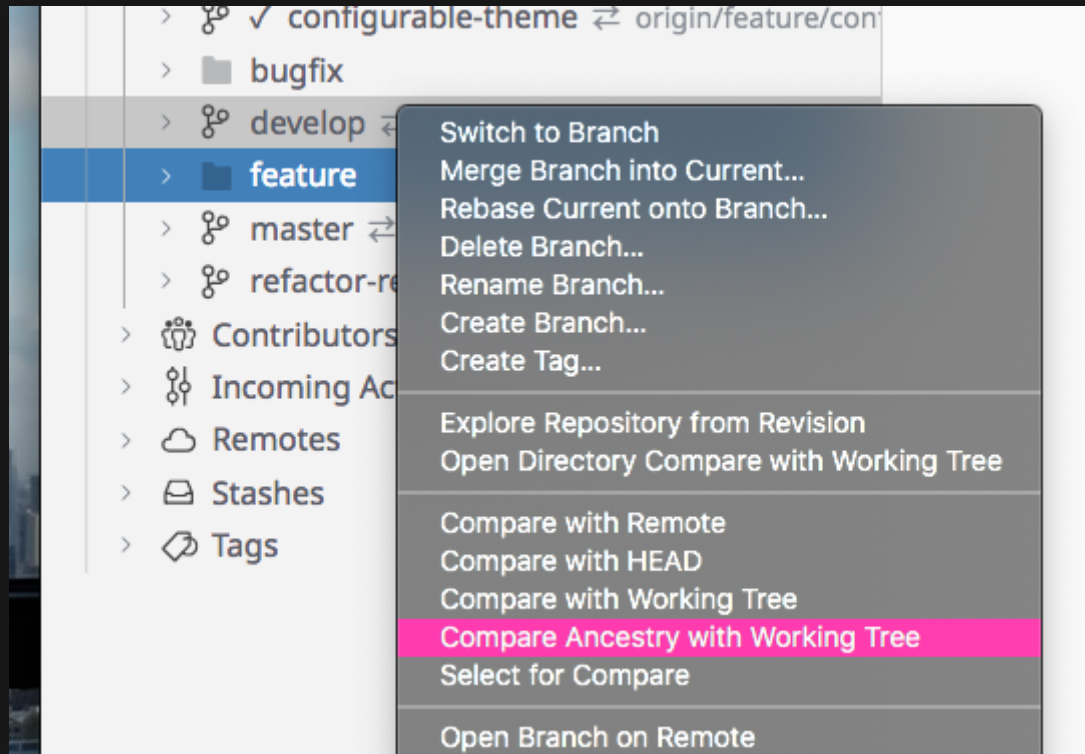

GITLENS

REPOSITORIES

- codimd feature/configurable-theme • +1 • Last f
- feature/configurable-theme ↔ origin/feature/c
- 1 file changed
- Compare feature/configurable-theme (workin

Branches

- configurable-theme ↔ origin/feature/con
- bugfix
- develop ↔ origin/develop • November 1st, 2
- Less than a week ago
- origin/develop » Update markdownli
- Fix linter error ... +0 -1 -0 • You, Novem
- Update markdownlint & webpack bundli

COMPARE

Compare <branch, tag, or ref> with <branch, tag, or

Comparing ancestry with develop (f4921a1) to Work

- 1 commit
- feature/configurable-theme, origin/featur
- 2 files changed
- index.js public/js/lib/editor
- statusbar.html public/js/lib/editor

```
493   }
494
495 -   const setTheme = theme
496 +   var themeToggle = this
497
498   1 +
499   2 +   const checkTheme = ()
500   3 +     var theme = this.edi
501   4 +     if (theme === 'one-d
502   5 +       themeToggle.remove
503   6 +     } else {
504   7 +       themeToggle.addCla
505   8 +     }
506   9 +   }
507  10 +
508  11 +   themeToggle.click(() =
509  12 +     var theme = this.edi
510  13 +     if (theme === 'one-d
511  14 +       theme = 'default'
512  15 +     } else {
513  16 +       theme = 'one-dark'
514  17 +     }
515  18 +   this.editor.setOptio
516  19 +   Cookies.set('theme',
517  20 +     expires: 365
518  21 +   })
519  22 +
520 -   }
```

feature/configurable-theme* 1 0 Spaces: 2 UTF-8 Babel JavaScript 1.5 hrs | 37 min

- ✓ Comparing ancestry with develop (f4921a1) to Work
- ✓ 1 commit
 - >  feature/configurable-theme, origin/featur
- ✓ 2 files changed
 -  index.js public/js/lib/editor
 -  statusbar.html public/js/lib/editor

GITLENS

REPOSITORIES

- codimd feature/configurable-theme • +1 • Last f
- feature/configurable-theme ↔ origin/feature/c
- 1 file changed
- Compare feature/configurable-theme (workin

Branches

- configurable-theme ↔ origin/feature/con
- bugfix
- develop ↔ origin/develop • November 1st, 2
- Less than a week ago
- origin/develop » Update markdownli
- Fix linter error ... +0 -1 -0 • You, Novem
- Update markdownlint & webpack bundli

COMPARE

Compare <branch, tag, or ref> with <branch, tag, or

Comparing ancestry with develop (f4921a1) to Work

- 1 commit
- feature/configurable-theme, origin/featur
- 2 files changed
- index.js public/js/lib/editor
- statusbar.html public/js/lib/editor

```
493   }
494
495 -   const setTheme = theme
496 +   var themeToggle = this
497
498   //
499   //
500 - }
501
502
503
504
505
506
507
508
509
510
511
512
513
514
515
516
517
518
519
520
521
522
523
524
525
526
527
528
529
530
531
532
533
534
535
536
537
538
539
540
541
542
543
544
545
546
547
548
549
550
551
552
553
554
555
556
557
558
559
560
561
562
563
564
565
566
567
568
569
570
571
572
573
574
575
576
577
578
579
580
581
582
583
584
585
586
587
588
589
590
591
592
593
594
595
596
597
598
599
600
601
602
603
604
605
606
607
608
609
610
611
612
613
614
615
616
617
618
619
620
621
622
623
624
625
626
627
628
629
630
631
632
633
634
635
636
637
638
639
640
641
642
643
644
645
646
647
648
649
650
651
652
653
654
655
656
657
658
659
660
661
662
663
664
665
666
667
668
669
670
671
672
673
674
675
676
677
678
679
680
681
682
683
684
685
686
687
688
689
690
691
692
693
694
695
696
697
698
699
700
701
702
703
704
705
706
707
708
709
710
711
712
713
714
715
716
717
718
719
720
721
722
723
724
725
726
727
728
729
730
731
732
733
734
735
736
737
738
739
740
741
742
743
744
745
746
747
748
749
750
751
752
753
754
755
756
757
758
759
760
761
762
763
764
765
766
767
768
769
770
771
772
773
774
775
776
777
778
779
780
781
782
783
784
785
786
787
788
789
790
791
792
793
794
795
796
797
798
799
800
801
802
803
804
805
806
807
808
809
810
811
812
813
814
815
816
817
818
819
820
821
822
823
824
825
826
827
828
829
830
831
832
833
834
835
836
837
838
839
840
841
842
843
844
845
846
847
848
849
850
851
852
853
854
855
856
857
858
859
860
861
862
863
864
865
866
867
868
869
870
871
872
873
874
875
876
877
878
879
880
881
882
883
884
885
886
887
888
889
890
891
892
893
894
895
896
897
898
899
900
901
902
903
904
905
906
907
908
909
910
911
912
913
914
915
916
917
918
919
920
921
922
923
924
925
926
927
928
929
930
931
932
933
934
935
936
937
938
939
940
941
942
943
944
945
946
947
948
949
950
951
952
953
954
955
956
957
958
959
960
961
962
963
964
965
966
967
968
969
970
971
972
973
974
975
976
977
978
979
980
981
982
983
984
985
986
987
988
989
990
991
992
993
994
995
996
997
998
999
```

feature/configurable-theme* 1 0 Spaces: 2 UTF-8 Babel JavaScript 1.5 hrs | 37 min

本機預覽 PR 的變更

fancy way

Git/GitHub 擴充功能大補帖

- GitLens
- → GitHub Pull Requests
- Git Graph



- > Local Pull Request Branches
- > Waiting For My Review
- > Assigned To Me
- > Created By Me
- ✓ All
 - ✕ Bugfix/slide mode printpdf #1339 by Yukaii
 - 🔗 Description
 - # slide.css public/css
 - > Configurable editor color scheme (t...
 - > chore(deps-dev): bump mini-css-ext...
 - > chore(deps): bump markdown-it-ma...
 - > chore(deps): bump i18n from 0.8.3 t...
 - > chore(deps): [security] bump bootst...
 - > chore(deps): bump aws-sdk from 2.!
 - > chore(deps): bump chance from 1.0
 - > chore(deps): bump uuid from 3.3.2 t...
 - > chore(deps): bump vega-embed from
 - > chore(deps-dev): bump webpack fro
 - > chore(deps): [security] bump eslint-
 - > 🇺🇦 Update pl.json #1297 by @SirPL
 - > Support embedding geolocation da
 - > WIP: Experimental *zen* editor the
 - > WIP: First working example of pand
 - > Fix/naming #1248 by @dragetd
 - > WIP: Experimental support for eth a

Bugfix/slide mode printpdf (#1339)

Checkout Refresh

Open Yukaii wants to merge changes into `hackmdio:develop` from `hackmdio:bugfix/slide-mode-printpdf`. Created 6 hours ago

Reviewers +

jackycute

Labels +

bug

Yukaii commented 6 hours ago

fixes #1246
related to #1299
Remove `eab984d` workaround

Changes

Before

After

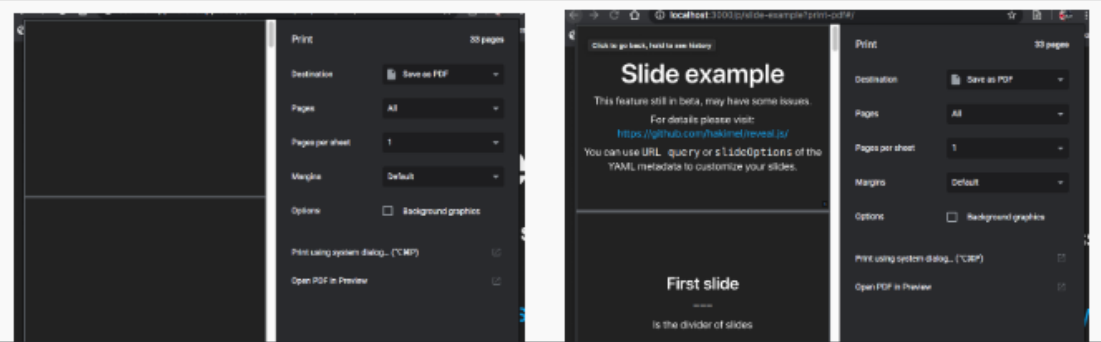

- > Local Pull Request Branches
- > Waiting For My Review
- > Assigned To Me
- > Created By Me
- > All

- Bugfix/slide mode printpdf #1339 by
 - Description
 - # slide.css public/css
 - Configurable editor color scheme (t
 - chore(deps-dev): bump mini-css-ext
 - chore(deps): bump markdown-it-ma
 - chore(deps): bump i18n from 0.8.3 t
 - chore(deps): [security] bump bootst
 - chore(deps): bump aws-sdk from 2.!
 - chore(deps): bump chance from 1.0
 - chore(deps): bump uuid from 3.3.2 t
 - chore(deps): bump vega-embed from
 - chore(deps-dev): bump webpack fro
 - chore(deps): [security] bump eslint-
 - Update pl.json #1297 by @SirPL
 - Support embedding geolocation da
 - WIP: Experimental *zen* editor the
 - WIP: First working example of pand
 - Fix/naming #1248 by @dragetd
 - WIP: Experimental support for eth a

Bugfix/slide mode printpdf (#1339)

Checkout Refresh

Open Yukaii wants to merge changes into hackmdio:develop from hackmdio:bugfix/slide-mode-printpdf.

Created 6 hours ago

在 VSCode 中 發 PR 審 PR 合 PR

Labels: bug

Yukaii committed 6 hours ago

fixes #1246 related to #1299 Remove eab9...



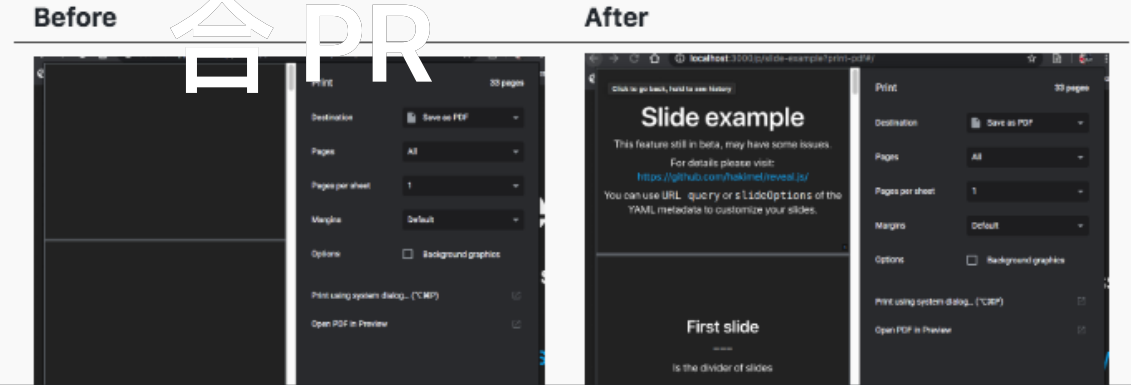











Changes



Git/GitHub 擴充功能大補帖

- GitLens
- GitHub Pull Requests
- → Git Graph

Branches: Show All Show Remote Branches 🔍 ⚙️ 🔄

Graph	Description	Date	Author	Commit
	Uncommitted Changes (1)	6 Nov 2019 19:48	*	*
 bugfix/slide-mode-printpdf <i>origin</i>	Remove transform-style workaround in eab...	6 Nov 2019 12:01	 Yukai Huang	7c329376
 feature/configurable-theme <i>origin</i>	Change theme toggle to theme select dropdo...	4 Nov 2019 09:11	 Yukai Huang	0471de5a
 develop <i>origin</i>	Update markdownlint & webpack bundling (#1...	1 Nov 2019 17:19	 Max Wu	f4921a12
	Fix linter error	1 Nov 2019 16:47	 Yukai Huang	f1586c57
	Update markdownlint & webpack bundling	1 Nov 2019 16:33	 Yukai Huang	bfc50b8b
	Merge pull request #1306 from hackmdio/feat...	1 Nov 2019 12:16	 Yukai Huang	aa5a50fa
	Merge branch 'develop' into feature/configura...	1 Nov 2019 10:27	 Yukai Huang	75ee5ad2
	Merge pull request #1327 from kamijin-fanta/g...	1 Nov 2019 10:22	 Yukai Huang	f871eff2
	Add https_proxy support to gitlab oauth (#129...	1 Nov 2019 10:22	 Yukai Huang	7fd36b1b
	github-login: move comment to default.js	30 Oct 2019 16:02	 kamijin_fanta	9e6f980d

Commit: 9e6f980d8d3422e0a3f178226e1445ca37009a95
Parents: b785ead5e5a9abe37f681f1281177ce9e00caed1
Author: kamijin_fanta <kamijin@live.jp>
Date: Wed Oct 30 2019 16:02:15 GMT+0800 (Taipei Standard Time)
Committer: kamijin_fanta



github-login: move comment to default.js
 Signed-off-by: kamijin_fanta <kamijin@live.jp>

```

lib
├── config
│   └── default.js (+1 | -1)
└── config.json.example (+0 | -1)
    
```

Branches: Show All Show Remote Branches 🔍 ⚙️ 🔄

Graph	Description	Date	Author	Commit
	Uncommitted Changes (1)	6 Nov 2019 19:48	*	*
<code>bugfix/slide-mode-printpdf</code> <i>origin</i>	Remove transform-style workaround in eab...	6 Nov 2019 12:01	Yukai Huang	7c329376
<code>feature/configurable-theme</code> <i>origin</i>	Change theme toggle to theme select dropdo...	4 Nov 2019 09:11	Yukai Huang	0471de5a
<code>develop</code> <i>origin</i>	Update markdownlint & webpack bundling (#1...	1 Nov 2019 17:19	Max Wu	f4921a12
	Fix linter error	1 Nov 2019 16:47	Yukai Huang	f1586c57
	Update markdownlint & webpack bundling	1 Nov 2019 16:33	Yukai Huang	bfc50b8b
	Merge pull request #1306 from hackmdio/feat...	1 Nov 2019 12:16	Yukai Huang	aa5a50fa
	Merge branch 'develop' into feature/configura...	1 Nov 2019 10:27	Yukai Huang	75ee5ad2
	Merge pull request #1327 from kamijin_fanta/g...	1 Nov 2019 09:12	kamijin_fanta	f871eff2
	add https://github.com/ryu support to oauti...	1 Nov 2019 09:12	Yukai Huang	7fd36b1b
	github-login: move comment to default.js	30 Oct 2019 16:02	kamijin_fanta	9e6f980d

在 VS Code 看 Git 綠圖!

Commit: 9e6f980d8d3422e0a3f178226e1445ca37009a95
Parents: b785ead5e5a9abe37f681f1281177ce9e00caed1
Author: kamijin_fanta <kamijin@live.jp>
Date: Wed Oct 30 2019 16:02:15 GMT+0800 (Taipei Standard Time)
Committer: kamijin_fanta

github-login: move comment to default.js

Signed-off-by: kamijin_fanta <kamijin@live.jp>



- lib
 - config
 - default.js (+1|-1)
 - config.json.example (+0|-1)

Live DEMO

說到 GitLen
還是得吹一下

Add tree-like layout to branches #258

Ed

 **Closed**

Yukaii opened this issue on Jan 25, 2018 · 2 comments



Yukaii on Jan 25, 2018

Contributor



- GitLens Version: 7.5.6
- VSCode Version: 1.19.2
- OS Version:

It' common to recognize branch name before `/` as folder name. In SourceTree:

▼ origin

- allow-workspace-tdsk-19
- avoid-fssync
- build-with-ts24
- cli-log-uploader
- contributable-applicati...
- css-json-shrinkwrap
- cursorStyle
- dockfind

Assignees

 eamodio

 Yukaii —unassign

type: feature

Notifications

You're receiving not...
you're watching this

 Unsu

Mark as

2 participants

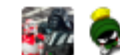

Add tree-like layout to branches #27

Closed Yukai opened this issue on Jan 25, 2018 · 2 comments



Yukai on Jan 25, 2018

- GitLens Version: 7.5.6
- VSCode Version: 1.19.2
- OS Version:

It's common to recognize branch name before `/` as folder name. In S

origin

- allow-workspace-tsd-19
- avoid-fssync
- build-with-ts24
- cli-log-uploader
- contributable-applicati...
- css-json-shrinkwrap
- cursorStyle
- dockfind

Contributor

Assignees

eamodio

Yukai —unassign

type: feature

Notifications

You're receiving not...
you're watching this

Unsub

Mark as

2 participants





Yukai on Jan 25, 2018 • edited ▾

Contributor

Author



I can't wait to see this happen, so I just made it 😂

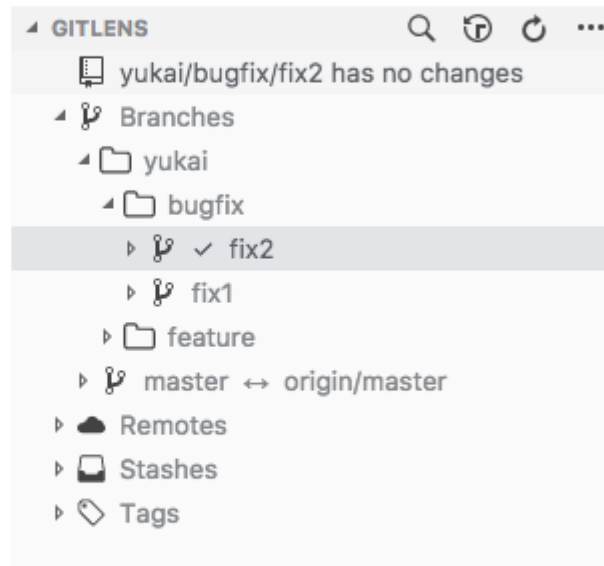

It's a prototype now, and I would submit a PR when it's ok 🐱

WIP on [Yukai/vscode-gitlens@improve-branch-folder](#) 🕒 branch



**想要新功能卻等不及？
自己來！**



Search or jump to...

[Pull requests](#) [Issues](#) [Trending](#) [Explore](#)

hackmdio / **codimd** ✓

Unwatch 148

Unstar 5.2k

Fork 671

Code

Issues 188

Pull requests 18

Actions

Wiki

Security

Insights

Settings

CodiMD - Realtime collaborative markdown notes on all platforms.

Edit

[hackmd](#) [collaboration](#) [realtime](#) [notes](#) [markdown](#) [codimd](#) [Manage topics](#)

2,431 commits

24 branches

21 releases

47 environments

124 contributors

AGPL-3.0

⚠ We found a potential security vulnerability in one of your dependencies.

You can see this message because you have been granted [access to security alerts](#) for this repository.

View security alert

Branch: develop

1.4.0-rc.2

Create new file

Find file

Clone or download

jackycute Update markdownlint & webpack bundling (#1332) ...

Latest commit f4921a1 5 days ago

bin	Remove BUILD_ASSETS env	3 months ago
contribute	Add sign you work section in contributing and DCO	2 years ago
deployments	fix: wrong permission caused user cannot upload image in docker	15 days ago
docs	Fix several typos in auth/saml.md	9 months ago
lib	Merge branch 'develop' into feature/configurable-break-style	5 days ago

hackmdio/codimd



VSCode 奇技淫巧的部分之二

打造自己的 VSCode 介面

Level 1

Colors & Font

mes

ck Theme by Luxcium +

css **html**

te</title>

ts -->
/>

ZeppelinImmigrantSong

javascript **css** html

```
<html lang="en">  
  
<head>  
  <title>HTML Template</title>  
</head>  
  
<body>  
  <main>  
    <!-- Page contents -->  
    <button id="btn" />  
  </main>  
</body>  
  
</html>
```

Tokyo Night Storm

javascript css **html**

```
<html lang="en">  
  
<head>  
  <title>HTML Template</title>  
</head>  
  
<body>  
  <main>  
    <!-- Page contents -->  
    <button id="btn" />  
  </main>  
</body>  
  
</html>
```

在 vscodethemes.com

選一套超讚的主題

One Dark Pro

css **html**

te</title>

ts -->
/>

Material Theme Palenight

javascript css **html**

```
<html lang="en">  
  
<head>  
  <title>HTML Template</title>  
</head>  
  
<body>  
  <main>  
    <!-- Page contents -->  
    <button id="btn" />  
  </main>  
</body>  
  
</html>
```

Dracula

javascript css **html**

```
<html lang="en">  
  
<head>  
  <title>HTML Template</title>  
</head>  
  
<body>  
  <main>  
    <!-- Page contents -->  
    <button id="btn" />  
  </main>  
</body>  
  
</html>
```

在 Programming Fonts

選一套超讚的字體

```
1 // Type some code →
2
3 console.log "o008 iILL1 g9qCGQ ~--+⇒";
4
5 function updateGutters(cm) {
6     var gutters = cm.display.gutters,
7         __specs = cm.options.gutters;
8
9     removeChildren(gutters);
10
11     for (var i = 0; i < specs.length; ++i) {
12         var gutterClass = __specs[i];
13         var gElt = gutters.appendChild(
14             elt(
15                 "div",
16                 null,
17                 "CodeMirror-gutter " + gutterClass
18             )
19         );
20         if (gutterClass == "CodeMirror-linenumbers") {
21             cm.display.lineGutter = gElt;
22             gElt.style.width = (cm.display.lineNumWidth || 1) + "px";
23         }
24     }
25     gutters.style.display = i ? "" : "none";
26     updateGutterSpace(cm);
27
28     return false;
29 }
30
31
```

monokai JavaScript

Cascadia

Cascadia Code

Code

Iosevka

順帶一題

我用的是 Menlo (Editor) + Iosevka
(Terminal)



Download Iosevka
Version 2.3.3



View Specimen
All characters & styles

EXPLORER

OPEN EDITORS

- package.json M
- release-notes.md public/docs 9+
- extra.js public/js 1

CODIMD

- features.md
- privacy.md.example
- release-notes.md 9+
- slide-example.md
- yaml-metadata.md
- fonts
- images
- js
 - lib
 - cover.js
 - extra.js 1
 - history.js
 - htmlExport.js
 - index.js
 - locale.js
 - mathjax-config-extra.js
 - pretty.js
 - render.js

OUTLINE

TODOS

- codimd
 - lib
 - ot
 - selection.js

FIXME Sort ranges before comparing

package.json release-notes.md extra.js

```

11   const timeregex = new RegExp(timeregex.source + spaceregex.source +
10   const nameandtimeregex = new RegExp(nameandtimeregex.source + spaceregex.source +
   timeregex.source + notinhtmltagregex.source, 'g')
9   nameregex = new RegExp(nameregex.source + notinhtmltagregex.source, 'g')
8   timeregex = new RegExp(timeregex.source + notinhtmltagregex.source, 'g')
7
6   function replaceExtraTags (html) {
5     html = html.replace(coloregex, '<span class="color" data-color="$1"></span>')
4     html = html.replace(nameandtimeregex, '<small><i class="fa fa-user"></i> $1
   <i class="fa fa-clock-o"></i> $2</small>')
3     html = html.replace(nameregex, '<small><i class="fa fa-user"></i> $1</
   small>')

```

COMMENTS PROBLEMS 638 OUTPUT DEBUG CONSOLE TERMINAL 1: fish

```

~/P/H/codimd ↵ release/1.4.0 *... ls                               Sun Nov 10 10
:49:36 2019
AUTHORS                bin                    lib                    utils
CHANGELOG.md           config.json            locales                webpack.common.js
CONTRIBUTING.md       config.json.example   node_modules           webpack.dev.js
LICENSE                 contribute              package-lock.json      webpack.htmlexport.js
README.md               deployments            package.json           webpack.prod.js
app.js                  docs                   public                 yarn.lock
app.json                ecosystem.config.js    test

```

```

~/P/H/codimd ↵ release/1.4.0 *...
~/P/H/codimd ↵ release/1.4.0 *...

```

release/1.4.0* 1 637 -- NORMAL -- Ln 254, Col 1 Spaces: 2 UTF-8 LF Babel JavaScript 0 min | 37 min

Level 2

混合特調 (Mix)

Mix?

EXPLORER

extension.ts x

OPEN EDITORS

- extension.ts src

MAP-REPLACE.JS

- .vscode
- doc
- node_modules
- out
- src
 - test
 - extension.ts
- .editorconfig
- .gitignore
- .vscodeignore
- CHANGELOG.md
- package-lock.json
- package.json
- README.md
- tsconfig.json

```
19 'use strict';
18 // The module 'vscode' contains the VS Code
    extensibility API
17 // Import the module and reference it with the alias
    vscode in your code below
16 import * as vscode from 'vscode';
15
14 interface PreviewRangesWithContent {
13     previewRange: vscode.Range;
12     originalRange: vscode.Range;
11     originalContent: string;
10     textToWrapInPreview: string[];
9 }
8
7 function validateInputFunction (inputFunctionString:
    string | undefined) : boolean {
6     if (typeof inputFunctionString === 'undefined') {
5         return false;
4     }
3
2     let inputFunction;
1     try {
20         inputFunction = eval(inputFunctionString);
1     } catch (e) {
2         return false;
3     }
4
5     if (typeof inputFunction !== 'function') {
6         return false;
```

Ln 20, Col 28 Spaces: 4 UTF-8 LF TypeScript 3.0.1 Prettier

A UI colors + B syntax colors
寫進 preference overwrite

Level 3

Custom UI

EXPLORER

OPEN EDITORS

- ✕ `window.ts` `src/vs/code/electron-main`

VSCODE

- resources
- scripts
- src
 - typings
 - vs
 - base
 - code
 - browser
 - electron-browser
 - electron-main
 - app.ts
 - auth.ts
 - main.ts
 - sharedProcess.ts
 - window.ts
 - windows.ts
 - windowsStateStorage.ts
 - node
 - test
 - buildfile.js
 - editor
 - platform
 - workbench
 - buildunit.json
 - css.build.js
 - css.d.ts
 - css.js
 - loader.js
 - managed.ts

TODOS

76

```
16 private _id: number;
15 private _win: Electron.BrowserWindow;
14 private _lastFocusTime: number;
13 private _readyState: ReadyState;
12 private windowState: IWindowState;
11 private currentMenuBarVisibility: MenuBarVisibility;
10 private representedFilename: string;
9
8 private readonly whenReadyCallbacks: { (window: ICodeWindow): void }[];
7
6 private currentConfig: IWindowConfiguration;
5 private pendingLoadConfig?: IWindowConfiguration;
4
3 private marketplaceHeadersPromise: Promise<object>;
2
1 private readonly touchBarGroups: Electron.TouchBarSegmentedControl[];

76 constructor(
1 config: IWindowCreationOptions,
2 @ILogService private readonly logService: ILogService,
3 @IEnvironmentService private readonly environmentService:
4 IEnvironmentService,
5 @IFileService private readonly fileService: IFileService,
6 @IConfigurationService private readonly configurationService:
7 IConfigurationService,
8 @IThemeMainService private readonly themeMainService: IThemeMainService,
9 @IWorkspacesMainService private readonly workspacesMainService:
10 IWorkspacesMainService,
11 @IBackupMainService private readonly backupMainService: IBackupMainService,
12 ) {
13   super();
14 }
```

Ln 76, Col 1 Tab Size: 2 UTF-8 LF TypeScript 3.5.2 4.3 hrs | 2.6 hrs

Vibrancy

Custom UI

EXPLORER

OPEN EDITORS

- swizzle.m modules/swizzle

CUSTOMIZE-UI

- .vscode
 - extensions.json
 - launch.json
 - settings.json
 - tasks.json
- modules
 - swizzle
 - build.sh
 - swizzle.m

OUTLINE

The active editor cannot provide outline information.

swizzle.m

```
#include <UIKit/UIKit.h>
#import <Foundation/Foundation.h>
#import <objc/runtime.h>

@interface Replacement : NSObject

@end

@implementation Replacement

- (void)imageViewDidLayout
{
    [self imageViewDidLayout];

    UIView * v = (UIView *)self;

    if (![v.window.className isEqualToString:@"AtomNSWindow"] ||
        v.window.titleVisibility != UIWindowTitleHidden)
    {
        return;
    }



    UIButton * button = [v.window standardWindowButton:UIWindowCl
```

Offset: 127 Ln 8, Col 1 Spaces: 4 UTF-8 LF Objective-C

Custom CSS



Custom CSS and JS Loader Preview

be5invis |  163,592 installs |  (26) | Free

Custom CSS and JS for Visual Studio Code

[Install](#) [Trouble Installing?](#)

[Overview](#) [Q & A](#) [Rating & Review](#)

Custom CSS and JS

Essence (already dead 🥲)



```
export class VSCodeWindow implements IVSCodeWindow {

    public static menuBarHiddenKey = 'menuBarHidden';
    public static colorThemeStorageKey = 'theme';

    private static MIN_WIDTH = 200;
    private static MIN_HEIGHT = 120;

    private options: IWindowCreationOptions;
    private hiddenTitleBarStyle: boolean;
    private showTimeoutHandle: any;
    private _id: number;
    private _win: Electron.BrowserWindow;
    private _lastFocusTime: number;
    private _readyState: ReadyState;
    private _extensionDevelopmentPath: string;
    private windowState: IWindowState;
    private currentWindowMode: WindowMode;

    private whenReadyCallbacks: TValueCallback<VSCodeWindow>[];

    private currentConfig: IWindowConfiguration;
    private pendingLoadConfig: IWindowConfiguration;

    constructor(
        config: IWindowCreationOptions,
        @ILogService private logService: ILogService,
        @IEnvironmentService private environmentService: IEnvironmentService,
        @IConfigurationService private configurationService: IConfigurationService,
        @IStorageService private storageService: IStorageService
```



VSCode 奇技淫巧的部分之三

在公司想看 PTT 怎麼辦？

在公司想看 PTT 怎麼辦？

就直接看啊

用 VSCode 來看啊！

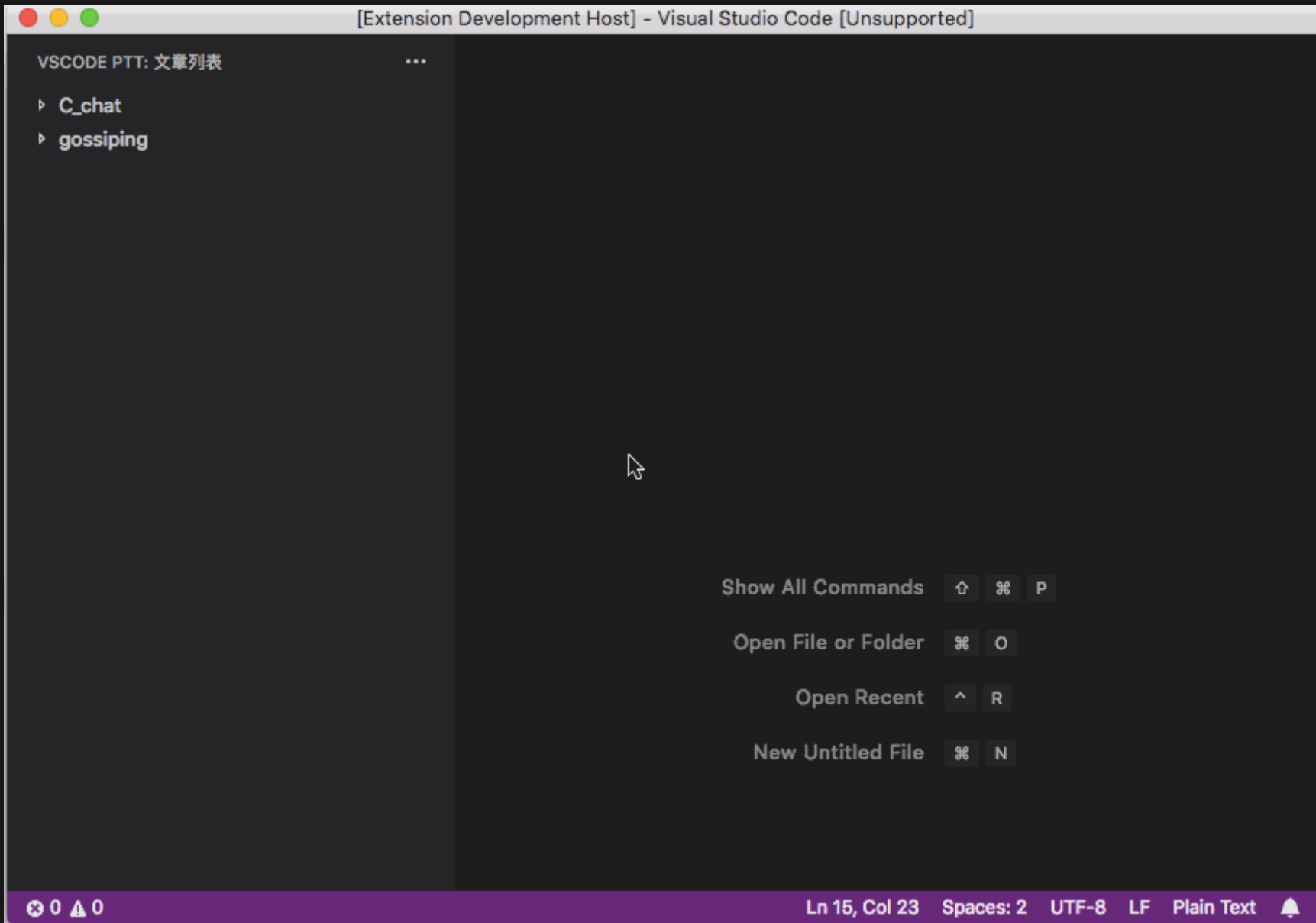

上 VSCode Marketplace 搜尋 PTT

Visual Studio | Marketplace

Visual Studio Code > Other > VSCode 批踢踢 (VSCode PTT)

VSCode 批踢踢 (VSCode PTT) Preview

Yukai Huang | 1,066 installs | ★★★★★ (5) | Free

PTT Client for VSCode

[Install](#) [Trouble Installing?](#)

[Overview](#) [Q & A](#) [Rating & Review](#)

vscode-ptt

自己的擴充功能自己寫！

譁眾取寵



map-replace.js — Replace multi-selection text with custom JavaScript function

Yukai Huang | 5,191 installs | (2) | Free

Replace multi-selection text with custom JavaScript function

Install

[Trouble Installing?](#)

map-replace.js



```
1  const things = [  
2    'Thing',  
1    'Thing',  
2    'Thing',  
3    'Thing',  
4    'Thing',  
5    'Thing',  
6    'Thing',  
7  ]  
8
```

來寫 VSCode Extensions!

- 用 VSCode 開發
- TypeScript 絕佳開發體驗
- 有點紅海子

來！

VSCode 簡介的部分
VSCode 獨步全球的部分
VSCode 奇技淫巧的部分

Tony Stark, played by Robert Downey Jr., is shown from the chest up, wearing a dark pinstriped tuxedo jacket, a white dress shirt, and a dark bow tie. He has a serious expression and his arms are outstretched to the sides. The background is a bright, colorful, and slightly blurred scene, possibly a stage or a party, with warm yellow and orange tones on the left and cooler blue and purple tones on the right.

通通都給我各來一份！

Fin

VSCode 台灣



<https://bit.ly/33v2MmA>

Markdown 台灣



<https://bit.ly/2MNfisR>